



**DIVISION: 06 00 00—WOOD PLASTICS AND COMPOSITES**

**Section: 06 17 33—Wood I-joists**

**REPORT HOLDER:**

**APA—THE ENGINEERED WOOD ASSOCIATION**

**EVALUATION SUBJECT:**

**PERFORMANCE RATED I-JOISTS**

**ADDITIONAL LISTEES:**

**EACOM TIMBER CORPORATION**

**IB EWP, INC.**

**NORDIC STRUCTURES**

**ROSEBURG FOREST PRODUCTS**

**RESOLUTE ENGINEERED WOOD LAROUCHE, INC.**

**RESOLUTE ENGINEERED WOOD ST. PRIME LIMITED PARTENERSHIP**

**STARK TRUSS COMPANY, INC.**

## 1.0 EVALUATION SCOPE

**Compliance with the following codes:**

- 2021, 2018, 2015 and 2012 *International Building Code*® (IBC)
- 2021, 2018, 2015 and 2012 *International Residential Code*® (IRC)

**Properties evaluated:**

- Structural
- Fire resistance

## 2.0 USES

The prefabricated wood I-joists described in this report are used as floor joists, roof rafters and blocking to support code-required loads. The wood I-joists comply with Section 2303.1.2 of the IBC; and Section R502.1.2 of the 2021, 2018 and 2015 IRC, Section R802.1.8 of the 2021 and 2018 IRC, and Section R502.1.4 of the 2012 IRC, for allowable stress design.

## 3.0 DESCRIPTION

### 3.1 General:

The prefabricated wood I-joists described in this report comply with the “PRI-400 Performance Standard for Residential I-joists,” dated October 2021, for the performance rating of prefabricated, performance-rated I-joists (PRI) used in floors of residential construction. The standard is promulgated by APA—The Engineered Wood Association. The standard complies with the requirements of the codes specifically referenced in Section 1.0 of this report, and with ASTM D5055 and the ICC-ES Acceptance Criteria for Prefabricated Wood I-joists (AC14). PRI-400 also complies with the code sections referenced in Section 2.0 of this report.

### 3.2 Materials:

**3.2.1 Flanges:** The flanges are sawn lumber or structural composite lumber (SCL), with both flanges having a minimum net width and thickness of 1½ inches (38 mm), except the minimum flange thickness can be 1⅝ inches (33.3 mm) for structural composite lumber. The structural composite lumber used as flanges are recognized in an ICC-ES evaluation report issued to the manufacturer of the structural composite lumber, or are recognized in the ICC-ES evaluation report issued to the I-joist manufacturer. The structural composite lumber has a minimum equivalent specific gravity of 0.42, as it relates to fastener capacity. Sawn lumber flanges have a minimum specific gravity of 0.42. The top flange is the same size, type, grade and species as the bottom flange.

**3.2.2 Webs:** The webs have a minimum thickness of ⅜ inch (9.5 mm) and are Exposure 1, exterior-grade, plywood or oriented strand board panels, and comply with DOC PS 1 or DOC PS 2.

**3.2.3 Adhesive:** The webs are adhered to the flanges with exterior-type adhesive complying with ASTM D2559 and Section 5.4.3 of ASTM D5055.

## 4.0 DESIGN AND INSTALLATION

### 4.1 Design:

Designed installations of the I-joists must be based on the allowable design properties in Table 1. Holes in webs of joists must comply with Figure 1 and Table 2. Where required by Table 1 and the notes to Figure 2, web stiffeners at joist supports must comply with Figure 2.

### 4.2 Installation:

**4.2.1 General:** I-joists produced by manufacturers listed in this report, or those complying with the requirements of PRI-400 and recognized in a separate ICC-ES evaluation report issued to the I-joist manufacturer, must be installed in accordance with this report. The separate evaluation report

issued to the I-joint manufacturer must indicate the I-joists have been evaluated for compliance with this report, and that they are to be installed in accordance with this evaluation report and the separate report.

The I-joint properties in this evaluation report are based on I-joists installed such that the in-service moisture content of the joists does not exceed 16 percent.

The compression flange of the joists must have continuous lateral support. In single-span, simply-supported conditions, the compression flange is the top flange of the joist, and lateral support is normally provided by the floor sheathing attached to the top flange. Lateral support for the I-joint bottom flange must be provided at interior supports of multiple-span joists, and the support adjacent to the unsupported end of cantilevered joists.

The ends of joists must be restrained to prevent rollover. This restraint is normally provided by diaphragm sheathing attached to the top flange and to an end wall or a shear-transfer panel capable of transferring a force of 50 pounds per foot (730 N/m). Blocking with equivalent strength is permitted to be used.

Concentrated loads in excess of 1,500 pounds (6672 N), applied to the top flange of the I-joint, require installation of web stiffeners in accordance with Figure 2, except the gap must be at the bottom flange. Blocking or squash blocks must be installed where concentrated loads occur at I-joint supports.

Spacing for nails installed in sawn lumber flanges of I-joists must be sufficient to prevent splitting of the wood. Allowable loads for nails in solid-sawn-lumber flanges must be in accordance with the allowable loads specified in the applicable code for spruce-pine-fir with a specific gravity of 0.42.

Spacing for nails installed in SCL flanges of joists must be sufficient to prevent splitting of the wood. Allowable loads for nails installed in SCL flanges must be in accordance with those in the applicable code for solid-sawn lumber with a specific gravity of 0.42. Fastener type and fastener penetration into the top flange of the I-joint, for fasteners attaching subfloor sheathing or the combination of subfloor and underlayment to the I-joint, must comply with the requirements of the applicable code. For engineered design, the designer must specify the proper I-joint designation and flange configuration to match the calculation assumptions.

**4.2.2 One-hour Fire-resistive Floor-ceiling Assemblies:** I-joists produced by manufacturers listed in this report, or complying with the requirements of PRI-400 and recognized in a separate ICC-ES evaluation report issued to the I-joint manufacturer, may be used as wood structural framing members in one-hour fire-resistive floor-ceiling assemblies when the assemblies are constructed in accordance with Sections 4.2.2.1 through 4.2.2.5 of this report.

**4.2.2.1 Assembly 1:** The assembly must be as described in Figure 3.

**4.2.2.2 Assembly 2:** The I-joists are permitted to be used in lieu of the wood joists or trusses in the one-hour floor-ceiling assemblies described in ICC-ES evaluation report [ESR-1338](#), and described in item 21-1.1 of 2021, 2018, 2015 and 2012 IBC Table 721.1(3). Minimum flange dimensions for the joists are 1.5 inches (38 mm) for width and  $1\frac{5}{16}$  inches (33 mm) for thickness. The thickness of wood structural panels for the floor must not be less than  $\frac{1}{2}$  inch (12.7 mm), nor less than required by the applicable code.

**4.2.2.3 Assembly 3:** The assembly must consist of a single-layer floor of minimum  $\frac{3}{4}$ -inch (19.1 mm) tongue-and-groove plywood, or minimum  $2\frac{3}{32}$ -inch (18.3 mm) tongue-and-groove wood structural panels (exposure 1 or exterior-grade), conforming to DOC PS 1 or PS 2, or an ICC-ES evaluation report, with I-joists spaced up to 24 inches (610 mm) on center; and a ceiling of two layers of  $\frac{1}{2}$ -inch-thick (12.7 mm), Type C gypsum board [two layers of  $\frac{5}{8}$ -inch-thick (15.9 mm), Type X gypsum board must be used for installations using I-joists flanges smaller than  $1\frac{1}{2}$  by  $1\frac{3}{4}$  inches (38 by 44.5 mm)] applied to the bottom chord. Minimum flange dimensions of the I-joists are  $1\frac{5}{16}$  inches by  $1\frac{1}{2}$  inches (33 mm by 38 mm).

The floor sheathing must be installed in accordance with code requirements or with applicable ICC-ES evaluation reports, with all butt joints located on framing members.

The first layer of gypsum board must be attached with  $1\frac{5}{8}$ -inch-long (41.3 mm), Type W screws spaced up to 12 inches (305 mm) on center. The second layer of gypsum board must be installed with the joints staggered from the first layer and must be fastened with 2-inch-long (51 mm) [ $2\frac{1}{4}$  inches (57 mm) long for  $\frac{5}{8}$ -inch (15.9 mm) gypsum board], Type W screws spaced up to 12 inches (305 mm) on center in the field and up to 8 inches (203 mm) on center at the butt joints. Type G screws,  $1\frac{1}{2}$  inches (38 mm) long [ $1\frac{3}{4}$  inches (44.5 mm) long for  $\frac{5}{8}$ -inch (15.9 mm) gypsum board], must be spaced up to 8 inches (203 mm) on center and up to 6 inches (152 mm) each side of the butt joint. The second layer must be finished with joint tape and compound.

Resilient channels are permitted to be used as part of the ceiling attachment system, provided they are spaced up to 16 inches (406 mm) on center. The resilient channels are permitted to be spaced up to 24 inches (610 mm) on center, if I-joists are spaced up to 16 inches (406 mm) on center. The channels are fastened perpendicular to joists with 1-inch-long (25.4 mm), case-hardened-steel, 0.15-inch-diameter-shank (0.38 mm), self-drilling, self-tapping, Phillips-head screws. The ceiling must be attached to the resilient channels as described above, except 1-inch (25.4 mm), Type S screws and  $1\frac{5}{8}$ -inch (41.3 mm), Type S screws must be used for the first and second layers, respectively, spaced at up to 12 inches (305 mm) on center.

When used as a roof-ceiling assembly, the decking is permitted to be any wood deck specified in the code, and the I-joint spacing is permitted to exceed 24 inches (610 mm) on center. However, when the I-joint spacing exceeds 24 inches (610 mm), the ceiling attachment system, including the resilient channels, must be applied to stripping spaced up to 24 inches (610 mm) on center. The attachment to the stripping is similar to the previously described attachment to the joists. The stripping must be either nominal 2-by-4-inch, construction-grade Douglas fir lumber [for spans of up to 5 feet (1524 mm)] attached to the bottom chord with two 10d box nails, or material and attachment of equivalent strength.

**4.2.2.4 Assembly 4:** The assembly must be as described in Figure 4.

**4.2.2.5 Other Fire-resistive Assemblies:** The I-joists described in this report may be used in the assemblies described in 2021, 2018, 2015 and 2012 IBC Table 721.1(3), Item Numbers 23-1.1 through 28.1.1, and Item Number 30-1.1 (2021, 2018 and 2015 IBC only), provided the I-joists used meet the criteria described in the table's "Floor or Roof Construction" column. For the purposes of the minimum flange area requirement of 2.3 square inches (1480 mm<sup>2</sup>) in Item Number 23-1.1, a  $1\frac{1}{2}$ -by- $1\frac{1}{2}$ -inch

(38 mm by 38 mm) flange having a cross-sectional area of 2.25 square inches (1450 mm<sup>2</sup>) may be considered sufficient.

#### 4.3 Fire Protection of Floors:

The I-joists described in this report, when installed and protected as specified in Figure 5, meet the provisions of 2021, 2018 and 2015 IRC Section R302.13 and 2012 IRC Section R501.3. The I-joists described in this report, when installed and protected as specified in Figures 6 through 10, are alternatives to the 2-by-10 dimensional lumber prescribed in 2021, 2018 and 2015 IRC Section R302.13 and 2012 IRC Section R501.3 Exception 4, and have met the requirements for a floor assembly demonstrating equivalent floor performance.

#### 5.0 CONDITIONS OF USE

The Performance Rated I-joists described in this report comply with, or are a suitable alternative to what is specified in, those codes listed in Section 1.0 of this report, subject to the following conditions:

- 5.1 The I-joists must be produced by a manufacturer listed in this report or must be evaluated in a current ICC-ES evaluation report issued to the I-joist manufacturer.
- 5.2 The design and installation must comply with this report and the wood design provisions noted in the applicable edition of the National Design Specification® for Wood Construction (NDS) referenced in the applicable code.
- 5.3 Drawings and design calculations demonstrating compliance with this report must be submitted to the building official. The drawings and calculations must be prepared by a registered design professional where required by the statutes of the jurisdiction in which the project is to be constructed.
- 5.4 No cutting of I-joist flanges is permitted.
- 5.5 The I-joists must be produced at the manufacturing plants noted in Table 3, under a quality-control program with inspections by ICC-ES and APA—The Engineered Wood Association (AA-649).

#### 6.0 EVIDENCE SUBMITTED

- 6.1 PRI-400 Performance Standard for Residential I-joists, dated October 2021.
- 6.2 Data verifying compliance with the ICC-ES Acceptance Criteria for Prefabricated Wood I-joists (AC14), dated June 2019 (Editorially revised February 2021).
- 6.3 Reports of fire tests conducted in accordance with ASTM E119.

#### 7.0 IDENTIFICATION

- 7.1 The I-joists must be identified by a stamp indicating the product designation, the evaluation report number (ESR-1405), the manufacturer's name, and the name and logo of the inspection agency (ICC-ES and APA—The Engineered Wood Association).

- 7.2 The report holder's contact information is the following:

**APA—THE ENGINEERED WOOD ASSOCIATION**  
**7011 SOUTH 19<sup>TH</sup> STREET**  
**TACOMA, WASHINGTON 98466**  
**(253) 565-6600**  
[www.apawood.org](http://www.apawood.org)  
[help@apawood.org](mailto:help@apawood.org)

- 7.3 The additional listees' contact information is the following:

**EACOM TIMBER CORPORATION**  
**1195 PEOPLES ROAD**  
**SAULT STE. MARIE, ONTARIO P6C 3W7**  
**CANADA**

**IB EWP, INC.**  
**480 JOCELYN-BASTILLE**  
**POHENEGAMOOK, QUEBEC G0L 1J0**  
**CANADA**

**NORDIC STRUCTURES**  
**1100 DE LA GAUCHETIERE STREET WEST**  
**SUITE 504**  
**MONTREAL, QUEBEC H3B 2S2**  
**CANADA**

**ROSEBURG FOREST PRODUCTS**  
**POST OFFICE BOX 1088**  
**ROSEBURG, OREGON 97470**

**RESOLUTE ENGINEERED WOOD LAROUCHE**  
**INC.**  
**900 CHEMIN DU LAC HIPPOLYTE**  
**LAROUCHE, QUEBEC, G0W 1Z0**  
**CANADA**

**RESOLUTE ENGINEERED WOOD ST. PRIME**  
**LIMITED PARTNERSHIP.**  
**101 RUE DU PARC INDUSTRIEL**  
**ST-PRIME, QUEBEC G8J 1H3**  
**CANADA**

**STARK TRUSS COMPANY, INC.**  
**6855 CHESTNUT RIDGE ROAD NW**  
**BEACH CITY, OHIO 44608**

TABLE 1—DESIGN PROPERTIES FOR APA EWS PERFORMANCE-RATED I-JOISTS<sup>1</sup>

JOIST DEPTH (in)	JOIST SERIES	EI <sup>(2)</sup> x10 <sup>6</sup> (lbf-in <sup>2</sup> )	M <sub>r</sub> <sup>(3)</sup> (lbf-ft)	V <sub>r</sub> <sup>(4)</sup> (lbf)	R <sub>r</sub> <sup>(5)</sup> (lbf)				VLC <sup>(8)</sup> (lbf/ft)	K <sup>(9)</sup> x10 <sup>6</sup> (lbf)	
					Intermediate Reaction <sup>(6)</sup>	End Reaction <sup>(7)</sup>					
						1 3/4" Bearing		4" Bearing			
						Web Stiffeners?					
No	Yes	No	Yes								
9 1/2"	PRI-20	132	2,520	1,120	1,700	830	830	1,120	1,120	2,000	4.94
	PRI-30	159	3,225	1,120	1,905	945	945	1,120	1,120	2,000	4.94
	PRI-40	184	2,735	1,120	2,160	1,080	1,080	1,120	1,120	2,000	4.94
	PRI-50	186	3,800	1,120	2,040	1,015	1,015	1,120	1,120	2,000	4.94
	PRI-60	219	3,780	1,120	2,160	1,080	1,080	1,120	1,120	2,000	4.94
11 7/8"	PRI-20	225	3,265	1,420	1,700	830	830	1,420	1,420	2,000	6.18
	PRI-30	271	4,170	1,420	1,905	945	945	1,420	1,420	2,000	6.18
	PRI-40	313	3,545	1,420	2,500	1,200	1,200	1,420	1,420	2,000	6.18
	PRI-50	316	4,915	1,420	2,040	1,015	1,015	1,420	1,420	2,000	6.18
	PRI-60	371	4,900	1,420	2,500	1,200	1,200	1,420	1,420	2,000	6.18
	PRI-70	416	6,595	1,420	2,335	1,160	1,160	1,420	1,420	2,000	6.18
	PRI-80	518	6,940	1,420	2,760	1,280	1,280	1,420	1,420	2,000	6.18
	PRI-90	571	8,770	1,925	3,355	1,400	1,400	1,885	1,925	2,000	6.18
14"	PRI-40	459	4,270	1,710	2,500	1,200	1,200	1,550	1,710	2,000	7.28
	PRI-50	463	5,860	1,710	2,040	1,015	1,015	1,550	1,710	2,000	7.28
	PRI-60	544	5,895	1,710	2,500	1,200	1,200	1,550	1,710	2,000	7.28
	PRI-70	609	7,865	1,710	2,335	1,160	1,160	1,550	1,710	2,000	7.28
	PRI-80	756	8,360	1,710	3,020	1,280	1,280	1,550	1,710	2,000	7.28
	PRI-90	832	10,460	2,125	3,355	1,400	1,400	1,885	2,125	2,000	7.28
16"	PRI-40	625	4,950	1,970	2,500	1,200	1,200	1,550	1,970	2,000	8.32
	PRI-50	630	6,715	1,970	2,040	1,015	1,015	1,550	1,970	2,000	8.32
	PRI-60	739	6,835	1,970	2,500	1,200	1,200	1,550	1,970	2,000	8.32
	PRI-70	826	9,010	1,970	2,335	1,160	1,160	1,550	1,970	2,000	8.32
	PRI-80	1,024	9,690	1,970	3,020	1,280	1,280	1,550	1,970	2,000	8.32
	PRI-90	1,126	11,985	2,330	3,355	1,400	1,400	1,885	2,330	2,000	8.32

For SI: 1 ft = 305 mm; 1 inch = 25.4 mm; 1 lbf = 4.448 N.

<sup>1</sup>The tabulated values are design values for normal duration of load (10 years). All values, except for EI, VLC and K, are permitted to be adjusted for other load durations in accordance with the NDS. The VLC values must be decreased for permanent loads per the NDS, but are not permitted to be increased for shorter durations.

<sup>2</sup>Reference design bending stiffness (EI) of the I-joist.

<sup>3</sup>The reference design moment (M<sub>r</sub>) of the I-joist must not be increased by any repetitive member use factor.

<sup>4</sup>Reference design shear (V<sub>r</sub>) of the I-joist.

<sup>5</sup>The reference design reactions (R<sub>r</sub>), after being adjusted by the load duration factor, C<sub>D</sub>, must meet the following requirement:

$$R_r(C_D) \leq F_{c\perp}(C_b)(b_{brg})(L_{brg})$$

Where: F<sub>c⊥</sub> = Reference compression design value perpendicular to grain (lbf/in<sup>2</sup>). Use the lesser of the F<sub>c⊥</sub> for the I-joist flange (refer to manufacturer) or the F<sub>c⊥</sub> for the supporting member.

C<sub>b</sub> = Bearing area factor as defined in Section 3.10.4 of the NDS, if applicable.

b<sub>brg</sub> = Bearing width of the I-joist (in). Typically equal to the flange width minus 0.15 inch edge easing (refer to manufacturer).

L<sub>brg</sub> = Bearing length of the I-joist (in).

<sup>6</sup>Intermediate reaction design values are based on a minimum bearing length of 3 1/2 inches, without web stiffeners.

<sup>7</sup>Interpolation of end reaction design values between tabulated bearing lengths is permitted, with or without bearing stiffeners.

<sup>8</sup>Vertical load capacity (VLC), for transfer of vertical uniform loads when I-joists are used as continuously-supported blocking.

<sup>9</sup>Deflection calculations must account for shear deformation, using the tabulated reference shear stiffness coefficient (K). For example, deflections of I-joists under uniform load or center-point load in simple-span applications are calculated as follows:

$$\text{Uniform Load: } \delta = \frac{5\omega\ell^4}{384EI'} + \frac{\omega\ell^2}{K'}$$

$$\text{Center-Point Load: } \delta = \frac{P\ell^3}{48EI'} + \frac{2P\ell}{K'}$$

Where: δ = Calculated deflection at center span (inches).

EI' = Bending stiffness, adjusted per NDS Section 7.3 (lbf-in<sup>2</sup>).

K' = Shear stiffness coefficient, adjusted per NDS Section 7.3 (lbf).

ℓ = Design span (inches)

ω = Uniform load (lbf/in).

P = Center point load (lbf).

Rules for cutting holes in the webs of PRI Joists:

1. The distance between the inside edge of the support and the centerline of any hole must be in compliance with the requirements of Table 2.
2. I-joist top and bottom flanges must NEVER be cut, notched, or otherwise modified.
3. Whenever possible, field-cut holes should be centered vertically along the depth of the web.
4. The maximum size hole that can be cut into an I-joist web must equal the clear distance between the flanges of the I-joist minus  $\frac{1}{4}$  inch. A minimum of  $\frac{1}{8}$  inch should always be maintained between the top or bottom of the hole and the adjacent I-joist flange.
5. The sides of square holes or longest sides of rectangular holes must not exceed three fourths of the diameter of the maximum round hole permitted at that location.
6. Where more than one hole is necessary, the distance between adjacent hole edges must exceed twice the diameter of the largest round hole or twice the size of the largest square hole (or twice the length of the longest side of the longest rectangular hole) and each hole must be sized and located in compliance with the requirements of Table 2.
7. Knockouts may be utilized anywhere they occur, and may be ignored for purposes of calculating minimum distances between holes.
8. A maximum  $1\frac{1}{2}$ -inch-diameter hole can be placed anywhere in the web (including along cantilevered spans) provided that it meets the requirements of 6 above.
9. Except for factory knockouts and maximum  $1\frac{1}{2}$ -inch-diameter holes (see note 8 above), the near edge of web holes must be at least 6 inches away from the nearest edge of a reaction (measured horizontally along the I-joist).
10. All holes must be cut in a workman-like manner in accordance with the restrictions listed above and as illustrated in Figure 1.
11. Limit 3 maximum size holes per span.
12. A group of round holes at approximately the same location is permitted if they meet the requirements for a single round hole circumscribed around them.

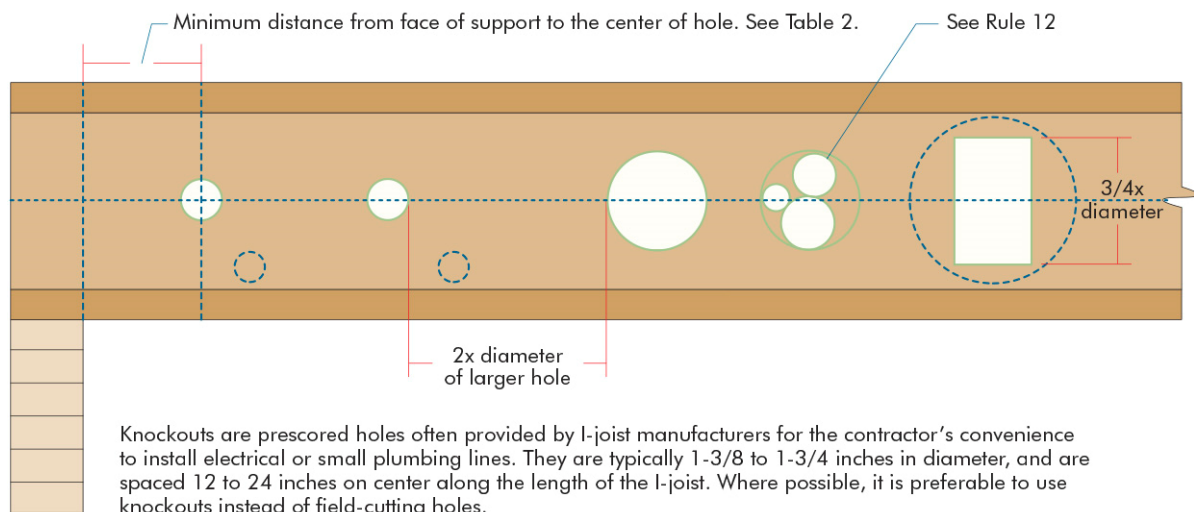

FIGURE 1—TYPICAL HOLES

**TABLE 2—LOCATION OF CIRCULAR HOLES IN PRI JOIST WEBS, SIMPLE OR MULTIPLE SPAN FOR DEAD LOADS UP TO 10 PSF AND LIVE LOADS UP TO 40 PSF<sup>1,2,3,4,5</sup>**

JOIST DEPTH (in)	JOIST SERIES	SAF <sup>6</sup>	MINIMUM DISTANCE FROM INSIDE FACE OF ANY SUPPORT TO CENTER OF HOLE (ft - in.)														
			Round Hole Diameter (in.)														
			2	3	4	5	6	6 <sup>1</sup> / <sub>4</sub>	7	8	8 <sup>5</sup> / <sub>8</sub>	9	10	10 <sup>3</sup> / <sub>4</sub>	11	12	12 <sup>3</sup> / <sub>4</sub>
9 <sup>1</sup> / <sub>2</sub> "	PRI-20	13'-1"	0'-7"	0'-11"	2'-2"	3'-6"	5'-0"	5'-5"									
	PRI-30	13'-9"	0'-9"	2'-0"	3'-3"	4'-7"	6'-1"	6'-6"									
	PRI-40	14'-4"	0'-7"	1'-8"	3'-0"	4'-4"	5'-9"	6'-3"									
	PRI-50	14'-5"	1'-1"	2'-4"	3'-8"	5'-0"	6'-6"	6'-11"									
	PRI-60	15'-0"	1'-7"	2'-10"	4'-2"	5'-7"	7'-1"	7'-6"									
11 <sup>7</sup> / <sub>8</sub> "	PRI-20	13'-5"	0'-7"	0'-8"	0'-8"	0'-9"	1'-11"	2'-4"	3'-7"	5'-8"	7'-0"						
	PRI-30	15'-0"	0'-7"	0'-8"	0'-8"	1'-9"	3'-4"	3'-9"	5'-0"	6'-10"	8'-0"						
	PRI-40	16'-7"	0'-7"	0'-8"	1'-2"	2'-5"	3'-9"	4'-1"	5'-1"	6'-8"	7'-11"						
	PRI-50	16'-1"	0'-7"	0'-8"	0'-11"	2'-5"	4'-1"	4'-6"	5'-9"	7'-7"	8'-10"						
	PRI-60	17'-10"	0'-7"	1'-9"	3'-0"	4'-4"	5'-9"	6'-1"	7'-2"	8'-9"	9'-10"						
	PRI-70	18'-5"	0'-7"	1'-2"	2'-5"	3'-9"	5'-2"	5'-7"	6'-11"	8'-10"	10'-1"						
	PRI-80	19'-7"	1'-8"	3'-0"	4'-3"	5'-7"	7'-1"	7'-5"	8'-7"	10'-2"	11'-4"						
	PRI-90	20'-2"	0'-7"	0'-8"	1'-1"	2'-9"	4'-6"	5'-0"	6'-5"	8'-5"	9'-9"						
14"	PRI-40	18'-3"	0'-7"	0'-8"	0'-8"	0'-9"	1'-10"	2'-2"	3'-2"	4'-7"	5'-5"	6'-0"	7'-7"	9'-4"			
	PRI-50	16'-1"	0'-7"	0'-8"	0'-8"	0'-9"	0'-9"	1'-0"	2'-5"	4'-4"	5'-7"	6'-5"	8'-7"	10'-5"			
	PRI-60	19'-9"	0'-7"	0'-8"	0'-8"	1'-7"	2'-10"	3'-3"	4'-6"	6'-3"	7'-4"	8'-1"	10'-0"	11'-8"			
	PRI-70	18'-6"	0'-7"	0'-8"	0'-8"	0'-11"	2'-6"	2'-11"	4'-2"	5'-11"	7'-0"	7'-10"	10'-1"	12'-0"			
	PRI-80	22'-2"	0'-7"	1'-9"	3'-0"	4'-4"	5'-8"	6'-1"	7'-1"	8'-7"	9'-7"	10'-3"	11'-11"	13'-5"			
	PRI-90	22'-10"	0'-7"	0'-8"	0'-8"	2'-1"	3'-8"	4'-1"	5'-4"	7'-1"	8'-3"	9'-0"	11'-0"	12'-7"			
16"	PRI-40	19'-8"	0'-7"	0'-8"	0'-8"	0'-9"	0'-9"	0'-10"	1'-5"	2'-9"	3'-7"	4'-1"	5'-6"	6'-7"	7'-0"	8'-9"	10'-9"
	PRI-50	16'-1"	0'-7"	0'-8"	0'-8"	0'-9"	0'-9"	0'-10"	0'-10"	0'-10"	1'-9"	2'-6"	4'-6"	6'-0"	6'-7"	9'-3"	11'-7"
	PRI-60	19'-9"	0'-7"	0'-8"	0'-8"	0'-9"	0'-9"	0'-10"	1'-10"	3'-6"	4'-6"	5'-2"	6'-11"	8'-6"	9'-1"	11'-5"	13'-4"
	PRI-70	18'-6"	0'-7"	0'-8"	0'-8"	0'-9"	0'-9"	0'-10"	1'-0"	2'-11"	4'-1"	4'-10"	6'-11"	8'-7"	9'-1"	11'-6"	13'-5"
	PRI-80	23'-11"	0'-7"	0'-8"	0'-8"	1'-7"	2'-11"	3'-3"	4'-6"	6'-2"	7'-3"	7'-11"	9'-9"	11'-3"	11'-9"	13'-11"	15'-7"
	PRI-90	25'-3"	0'-7"	0'-8"	0'-8"	0'-10"	2'-3"	2'-8"	3'-10"	5'-5"	6'-5"	7'-1"	8'-10"	10'-2"	10'-8"	12'-11"	14'-10"

For SI: 1 ft = 305 mm; 1 inch = 25.4 mm.

<sup>1</sup>Tabulated values apply where I-joists are spaced 24 inches on center or less.

<sup>2</sup>Hole location distance is measured from inside face of supports to center of hole.

<sup>3</sup>Distances in this chart are based on uniformly loaded joists.

<sup>4</sup>Tabulated values are based on the allowable spans given in APA PRI-400, which assume the I-joists act compositely with glued and nailed floor sheathing (See APA PRI-400). For multiple-span applications, the lengths of end spans must be at least 40% of the adjacent span length.

<sup>5</sup>Joists with web hole locations and/or sizes that fall outside of the scope of this table must be analyzed based on the actual hole size, joist spacing, span and loading conditions. The I-joist shear capacity at the location of a circular web hole, V<sub>rh</sub>, is calculated using the following equation: V<sub>rh</sub> = Published Shear Value x [(Joist Depth – Hole Diameter) / Joist Depth].

<sup>6</sup>SAF = Span Adjustment Factor, used as defined below.

**OPTIONAL:**

Table 2 is based on the I-joists being used at their maximum span. If the I-joists are placed at less than their full allowable span, the minimum distance from the centerline of the hole to the face of any support (D) as given above may be reduced as follows:

$$D_{\text{reduced}} = \frac{L_{\text{actual}}}{\text{SAF}} \times D$$

- Where:
- D<sub>reduced</sub> = Distance from the inside face of any support to center of hole, reduced for less-than-maximum span applications (ft). The reduced distance must not be less than 6 inches from the face of support to edge of the hole.
  - L<sub>actual</sub> = The actual measured span distance between the inside faces of supports (ft).
  - SAF = Span Adjustment Factor given in Table 2.
  - D = The minimum distance from the inside face of any support to center of hole from Table 2 above.

If  $\frac{L_{\text{actual}}}{\text{SAF}}$  is greater than 1.0, use 1.0 in the above calculation for  $\frac{L_{\text{actual}}}{\text{SAF}}$ .

Requirements for web stiffeners:

1. Wood Structural Panel web stiffeners must be placed on each side of the I-joist web at:
  - a) Hangers with side nailing
  - b) Hangers with a side, which do not support top flanges of I-joist.
  - c) Locations where concentrated loads in excess of 1,500 pounds are applied to the top flange of the I-joist between supports, or in the case of cantilever, anywhere between the cantilever tip and the support.
  - d) At exterior supports in engineered applications where concentrated loads cause exterior reaction loads to exceed 1,550 pounds.
2. Web stiffeners must be made of Utility grade SPF (south) or better for lumber and/or Sheathing grade or better for wood structural panels.

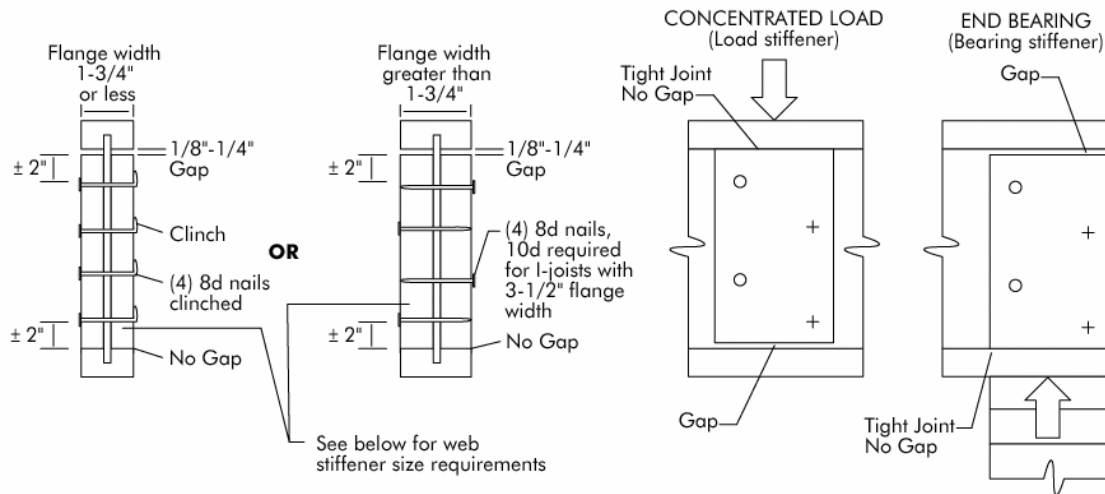

FIGURE 2—PRI I-JOIST WEB STIFFENER CONSTRUCTION DETAILS

Web stiffener size required

I-JOIST FLANGE WIDTH	WEB STIFFENER SIZE REQUIRED ON EACH SIDE OF WEB
1 1/2"	15/32" x 25/16" minimum width
1 3/4"	19/32" x 25/16" minimum width
2 5/16"	1" x 25/16" minimum width
2 1/2"	1" x 25/16" minimum width
3 1/2"	1 1/2" x 25/16" minimum width

For SI: 1 inch = 25.4 mm.

TABLE 3—MANUFACTURERS AND THEIR LOCATIONS

MANUFACTURER	LOCATION
EACOM Timber Corporation	1195 Peoples Road, Sault Ste. Marie, Ontario P6C 3W7, Canada
IB EWP, Inc.	480, Rue Jocelyn-Bastille, CP 10, Pohenegamook, Quebec G0L 1J0, Canada
Nordic Structures	521, Chemin Merrill, C.P. 216, Chibougamau, Quebec G8P 2K7, Canada
Roseburg Forest Products	4500 Riddle By-Pass Road, Riddle, Oregon 97469
Resolute Engineered Wood Larouche Inc.	900 Chemin du Lac Hippolyte, Larouche, Quebec G0W 1Z0, Canada
Resolute Engineered Wood St. Prime Limited Partnership	101 Rue du Parc Industriel, St-Prime, Quebec G8J 1H3, Canada
Stark Truss Company, Inc.	6855 Chestnut Ridge Road NW, Beach City, OH 44608

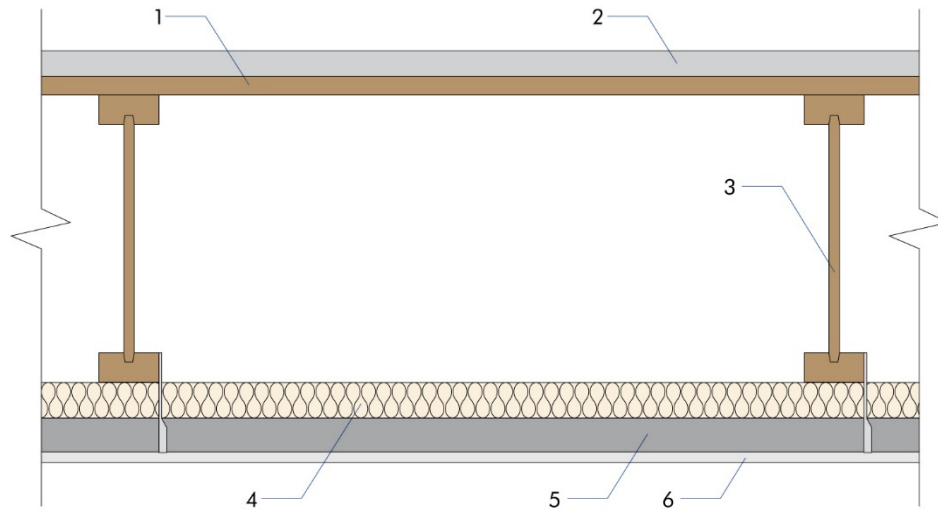

**FIGURE 3—ONE-HOUR FIRE-RESISTANCE-RATED FLOOR-CEILING ASSEMBLY (Ceiling—one layer of 1/2-inch or 5/8-inch gypsum wallboard, attached to furring channels spaced 24 inches on center)**

1. Single Floor – APA Rated Sturd-I-Floor wood structural panels (Exposure 1 or Exterior) with tongue-and-groove edges and conforming to APA Standard PRP-108, PS 1 or PS 2, with thickness, span rating and fastening in accordance with code requirements or ICC-ES evaluation reports (minimum  $2^{3}/_{32}$ -inch nominal thickness). Installed with long dimension of panel (strength axis) or face grain of plywood perpendicular to joists with end joints staggered. The panels must be nailed in addition to being glued to framing with construction adhesive conforming to ASTM D3498 (APA Specification AFG-01). The construction adhesive must be applied to the top flanges of I-joists and perimeter framing using a nominal  $1/4$ -inch diameter bead of adhesive, with double beads applied where panel end joints butt. A nominal  $1/4$ -inch diameter bead of adhesive also is applied in the groove of tongue-and-groove edges of panels before joining panels together.
2. Finish Flooring – Approved lightweight concrete floor topping ( $1\frac{1}{2}$  inches) or proprietary gypsum concrete floor topping optional over single floor, installed in accordance with an ICC-ES Evaluation Report. Minimum thickness of gypsum concrete topping is  $3/4$  inch with I-joists spaced maximum 19.2 inches on center, or 1 inch with I-joists spaced 24 inches on center.
3. Wood Structural Members – Minimum  $9\frac{1}{2}$ -inch deep wood I-joists spaced maximum of 24 inches on center, installed in accordance with requirements of this report. Top and bottom flanges, minimum size  $1\frac{1}{2}$ -inch x  $2\frac{1}{2}$ -inch LVL or  $1\frac{1}{2}$ -inch x  $2\frac{1}{2}$ -inch lumber; minimum web thickness  $3/8$  inch. Minimum 2 inches bearing on supports. Holes may be cut in web of I-joist as permitted by this report.
4. Insulation – 1-inch-thick unfaced mineral wool batt insulation (minimum 6 pounds per cubic foot density) must be placed under the bottom flange of I-joists and supported on furring channels. Edges of the insulation batts must be tightly buffed against the furring channel support clips and adjoining insulation batts, and ends must be located over furring channels.
5. Furring Channels – Inverted hat-type channels,  $7/8$ -inch deep x  $2^{5}/_{8}$ -inches wide, formed of minimum 0.021-inch thick (25 gage) galvanized steel. Channels must be installed perpendicular to I-joists in continuous rows spaced 24 inches on center. Channels must be attached to the bottom flange of each I-joist with one support clip (Simpson Strong-Tie Co. Type CSC) at each crossing. Support clips must be nailed to I-joist flange with one 11 gage (0.1205-inch diameter) x  $1\frac{1}{2}$ -inch nail. At locations of end joints of gypsum wallboard, install double row of channels, centered  $1\frac{1}{2}$  inches from panel ends. Ends of channel must extend a minimum of 6 inches beyond the edge joint of adjoining panels. Channel splices must be centered under the I-joists and overlapped a minimum of 6 inches, and tied together with double strand of No. 18 SWG galvanized steel wire near each end of overlap.
6. Wallboard, Gypsum – Approved  $1/2$ -inch or  $5/8$ -inch proprietary Type X gypsum wallboard, 48 inches wide, installed perpendicular to furring channels (parallel to I-joists) with end joints continuous or staggered. Fasten to furring channels with 1-inch or  $1\frac{1}{8}$ -inch Type S drywall screws spaced 12 inches on center. Drywall screws must be driven so that they are flush with the face and do not damage the core of the wallboard, and must be located  $1\frac{1}{2}$  inches from panel ends and a maximum of 6 inches from panel edges. The wallboard must be:
  - National Gypsum Fire-Shield Type C gypsum wallboard,
  - U. S. Gypsum Fire Code C gypsum wallboard.
7. Finishing System (not shown) – Exposed face layer joints must be covered with tape and joint compound, and screw heads must be covered with joint compound.



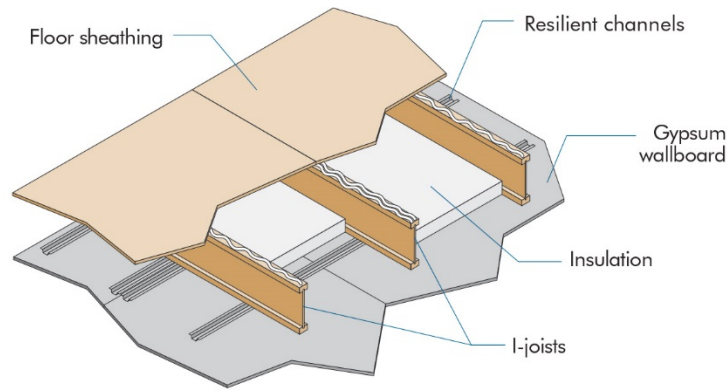

**FIGURE 4—ONE-HOUR FIRE-RESISTANCE-RATED FLOOR-CEILING ASSEMBLY  
(Ceiling—one layer of 3/4-inch Type X gypsum wallboard)**

For SI: 1 inch = 25.4 mm

**A. BASIC ASSEMBLIES**

- 1) Floor Topping (Optional): Varies (reference sound ratings if applicable).
- 2) Floor Sheathing: Min. 2<sup>3</sup>/<sub>32</sub>-inch T&G Wood Structural Panel. A construction adhesive must be applied to the top of the joists prior to placing sheathing. The sheets shall be installed with their long edge perpendicular to the joists with end joints centered over the top flange of joists. Floor sheathing must be installed per code requirements.
- 3) Insulation: Min. 3<sup>1</sup>/<sub>2</sub>-inch Fiber Glass Insulation (R13). Installed adjacent to the bottom flange of the I-joint and supported by the resilient channels.
- 4) Structural Members: Min. 9<sup>1</sup>/<sub>2</sub>-inch Deep I-Joists. Max. 24 inches on center spacing. Min. flange thickness of 1<sup>1</sup>/<sub>2</sub> inches and each lunge area of at least 3.75 inches<sup>2</sup>. Min. web thickness of 3/<sub>8</sub> inch.
- 5) Resilient Channels: Min. 0.019-inch Galvanized Resilient Channels. Attached perpendicular to the bottom flange of the I-joint with 1<sup>1</sup>/<sub>4</sub>-inch Type W drywall screws. Channels are spaced a max. of 16 inches on center, are doubled at each wallboard end joint, and extend to the next joist beyond each joint.
- 6) Ceiling: One layer of 3/<sub>4</sub>-inch Type X Gypsum Wallboard with a minimum weight of 3.0 lbf/ft<sup>2</sup> in compliance with ASTM C1396. Installed with long dimension perpendicular to resilient channels and fastened with min. 1<sup>1</sup>/<sub>8</sub>-inch Type S drywall screws spaced at 8 inches on center, and 1 inch from wallboard edges and 1<sup>1</sup>/<sub>2</sub> inches from wallboard ends. The end joints of the wallboard must be staggered.
  - a) Finish: The face joints must be covered with tape and coated with joint compound. Screw heads must also be covered with joint compound.

**B. SOUND RATING**

Components	STC	IIC
Base Assembly with cushioned vinyl	52	44
Base Assembly with Carpet and Padding	52	64
Base Assembly with cushioned vinyl, Gypsum Concrete	64	53
Base Assembly with Carpet and Padding, Gypsum Concrete	64	68

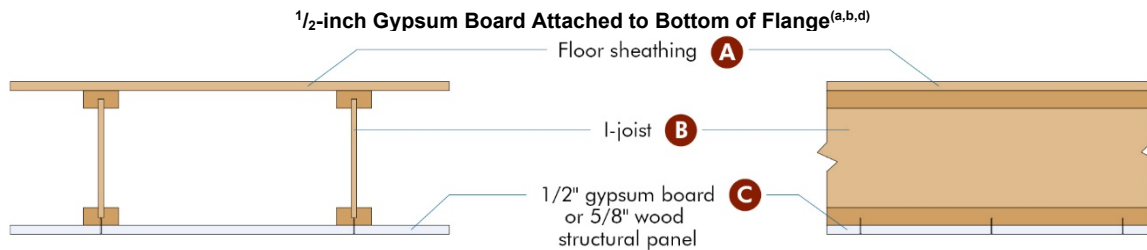

**Crawl Space Exception<sup>(b)</sup>**

In accordance with Exception 2 of the 2021, 2018 and 2015 IRC Section R302.13 and 2012 IRC Section R501.3, floor assemblies located directly over a crawl space not intended for storage or fuel-fired appliances do not require membrane protection.

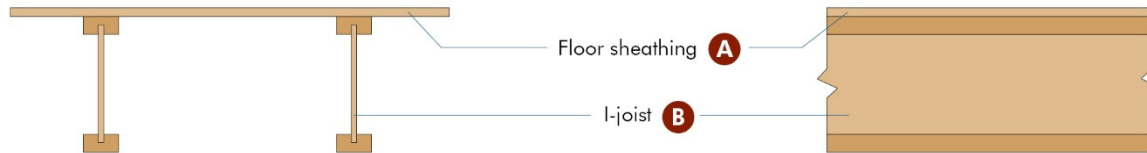

**Automatic Sprinkler Exception<sup>(c)</sup>**

In accordance with Exception 1 of the 2021, 2018 and 2015 IRC Section R302.13 and 2012 IRC Section R501.3, floor assemblies located directly over a space protected by an automatic sprinkler system do not require membrane protection.

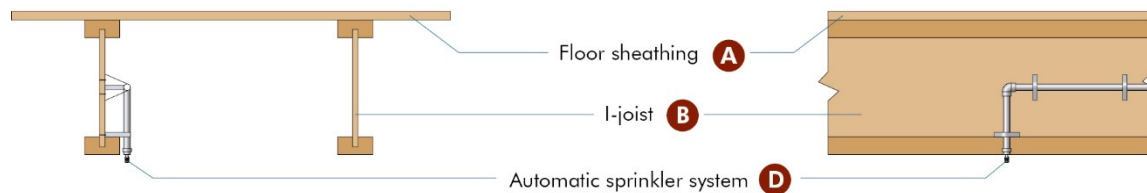

For SI: 1 inch = 25.4 mm

- (A) Floor sheathing: Materials and installation in accordance with 2021, 2018, 2015 and 2012 IRC Section R503.
- (B) I-joist: Installation in accordance with Section 4.0 of this report. Max. 24 inches on center spacing. Applicable to all flange sizes. Minimum web thickness of  $\frac{3}{8}$  inch. Adhesives used shall be as described in the quality manual approved by APA.
- (C) 1/2-inch gypsum board: Materials and installation in accordance with 2021, 2018, 2015 and 2012 IRC Section R702.3.1 or equivalent. 1x3 (nominal) wood furring strips are permitted to be installed perpendicular to the bottom flange of the I-joists at 16 inches on center provided that the gypsum boards are directly attached to the furring strips using 1- $\frac{1}{4}$ -inch (32-mm) Type W drywall screws at 12 inches (305 mm) on center. Gypsum board not required to be finished with tape and joint compound; or  $\frac{5}{8}$ -inch wood structural panel: Materials and installation in accordance with 2021, 2018, 2015 and 2012 IRC Section R503.2 or equivalent. Wood structural panel not required to be finished with wood filler or sanded.
- (D) Automatic sprinkler system: System in accordance with Section P2904 of the 2021, 2018, 2015 and 2012 IRC, NFPA 13D, or other equivalent sprinkler systems.

- Notes: (a) In accordance with Exception 3 of the 2021, 2018 and 2015 IRC Section R302.13 and the 2012 IRC Section R501.3, portions of floor assembly can be unprotected when complying with the following:
- 1) The aggregate area of the unprotected portions shall not exceed 80 square feet.
  - 2) Fire blocking in accordance with 2021, 2018, 2015 and 2012 IRC Section R302.11.1 shall be installed along the perimeter of the unprotected portion to separate the unprotected portion from the remainder of the floor assembly.
- (b) Insulation may be required for energy code compliance purposes. Check with the local building official for specific jurisdictional requirements.
- (c) In accordance with 2021, 2018, 2015 and 2012 IRC Section P2904, partial residential sprinkler systems are permitted to be installed only when the entire dwelling unit is not required to be equipped with a residential sprinkler system. Check with the local building official for specific jurisdictional requirements.
- (d) Penetrations or openings for ducts, vents, electrical outlets, lighting, devices, luminaires, wires, speakers, drainage, piping and similar openings or penetrations shall be permitted.

**FIGURE 5—2021, 2018, 2015 AND 2012 IRC FLOOR ASSEMBLY DETAILS**

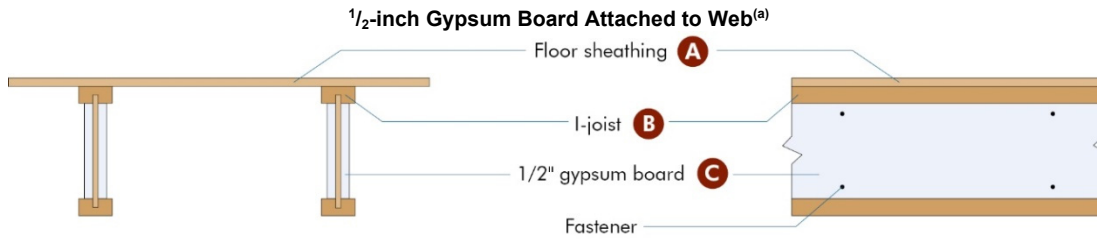

**Installation Requirements at Web Holes**

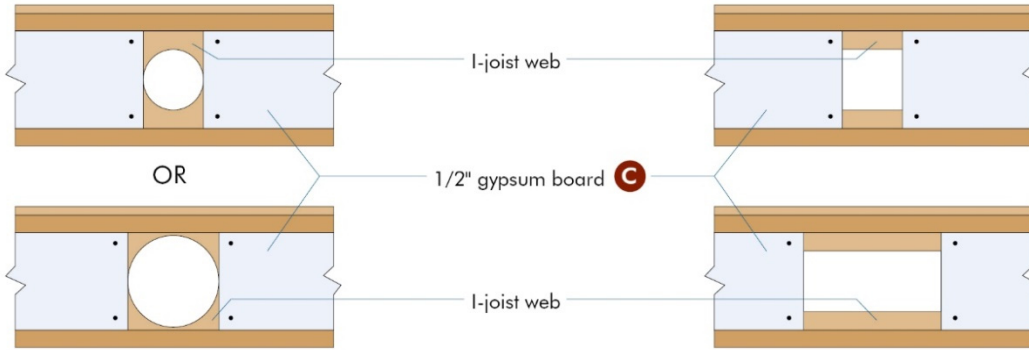

For SI: 1 inch = 25.4 mm

- (A) Floor sheathing: Materials and installation in accordance with 2021, 2018, 2015 and 2012 IRC Section R503.
  - (B) I-joist: Installation in accordance with Section 4 of this report. Maximum 24 inches on center spacing. Minimum flange size of 1 1/2 inches thick x 2 inches wide. Minimum web thickness of 3/8 inch. Adhesives used shall be as described in the quality manual approved by APA. At hole location, fasteners shall be installed 1 inch from the edge of the gypsum board.
  - (C) 1/2-inch gypsum board: Materials (entire length of I-joist) in accordance with 2021 2018, 2015 and 2012 IRC Section R702.3.1 (not required to be finished with tape and joint compound). Fasteners: Minimum 1-inch screws (Type W or Type S) or nails installed 1 inch from edges and 16 inches on center, top and bottom. Fasteners may be staggered from top to bottom.
- Note: (a) Penetrations or openings for ducts, vents, electrical outlets, lighting, devices, luminaires, wires, speakers, drainage, piping and similar openings or penetrations shall be permitted.

**FIGURE 6—FIRE PROTECTION: 1/2-INCH GYPSUM BOARD DIRECTLY ATTACHED TO WEB**

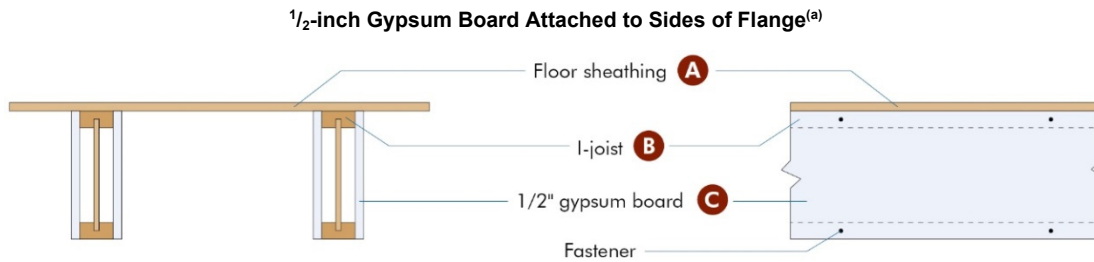

**Installation Requirements at Web Holes**

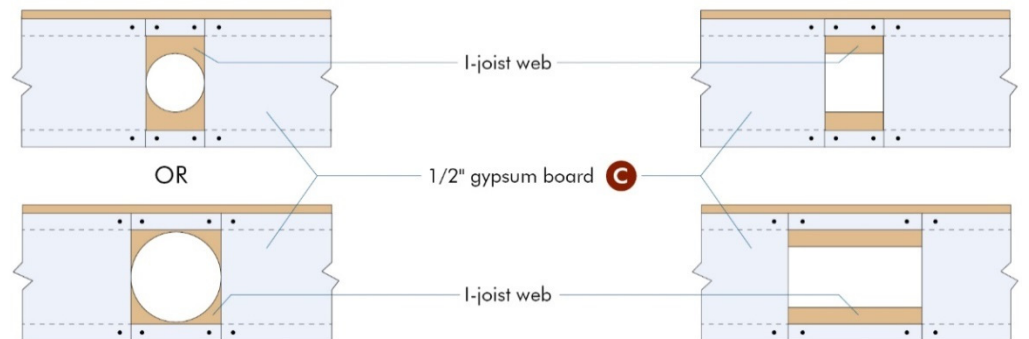

For SI: 1 inch = 25.4 mm

- (A) Floor sheathing: Materials and installation in accordance with 2021, 2018, 2015 and 2012 IRC Section R503.
  - (B) I-joist: Installation in accordance with Section 4.0 of this report. Maximum 24 inches on center spacing. Minimum flange size of 1 3/4 inches thick x 1 3/4 inches wide. Minimum web thickness of 3/8 inch. Adhesives used shall be as described in the quality manual approved by APA. At hole location, fasteners shall be installed 1/2 inch from the edge and 1 inch from the end of the gypsum board. Maximum fastener spacing shall be no more than 8 inches on gypsum board above and below the hole.
  - (C) 1/2-inch gypsum board: Materials (entire length of I-joist) in accordance with 2021, 2018, 2015 and 2012 IRC Section R702.3.1 (not required to be finished with tape and joint compound). Fasteners: Minimum 1-inch screws (Type W or Type S) or nails installed 1/2 inch from edges and 1 inch from ends, and 16 inches on center, top and bottom. Fasteners may be staggered from top to bottom.
- Note: (a) Penetrations or openings for ducts, vents, electrical outlets, lighting, devices, luminaires, wires, speakers, drainage, piping and similar openings or penetrations shall be permitted.

**FIGURE 7—FIRE PROTECTION: 1/2-INCH GYPSUM BOARD DIRECTLY ATTACHED TO SIDES OF FLANGE**

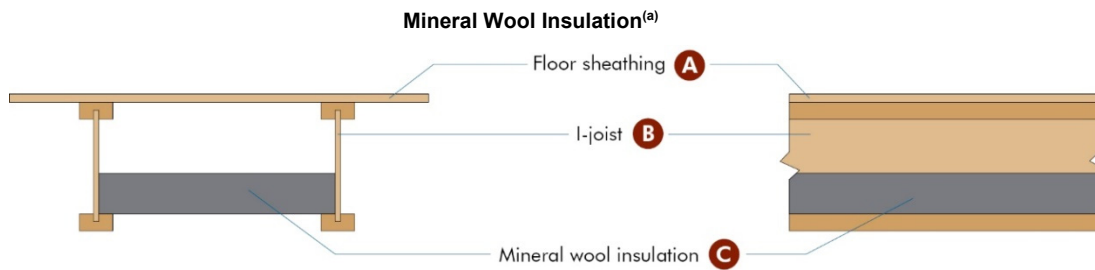

For SI: 1 inch = 25.4 mm

- (A) Floor sheathing: Materials and installation in accordance with 2021, 2018, 2015 and 2012 IRC Section R503.
  - (B) I-joist: Installation in accordance with Section 4.0 of this report. Maximum 24 inches on center spacing. Minimum flange size of 1 1/8 inches thick x 2 inches wide. Minimum web thickness of 3/8 inch. Adhesives used shall be as described in the quality manual approved by APA.
  - (C) Mineral wool batt insulation: Minimum 2.5 lb/ft<sup>3</sup> (nominal) and 3-inch-thick mineral wool batt insulation made of rock or furnace slag (ASTM C665 Type 1 compliant) installed as shown with insulation stay wire supports spaced no more than 24 inches apart and no more than 4 inches from ends of batts. Use minimum of 15 1/4-inch-, 18 1/2-, and 23-inch-wide insulation batt when I-joist spacing is 16 inches, 19.2 inches and 24 inches on center, respectively.
- Note: (a) Penetrations or openings for ducts, vents, electrical outlets, lighting, devices, luminaires, wires, speakers, drainage, piping and similar openings or penetrations shall be permitted.

**FIGURE 8—FIRE PROTECTION: MINERAL WOOL INSULATION**

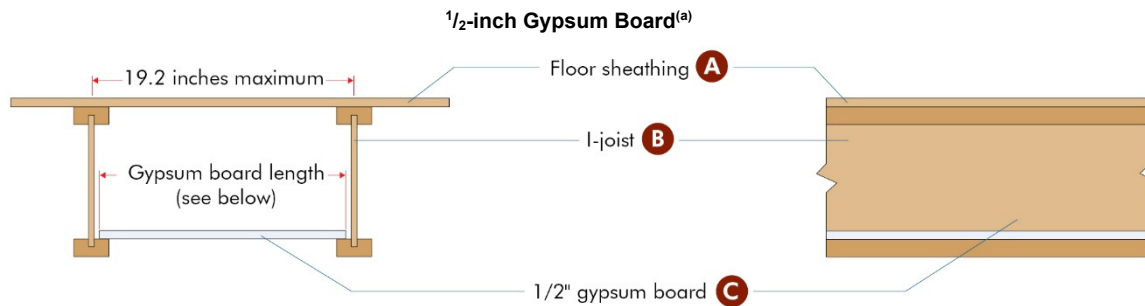

Joist spacing (in.)	Required length for gypsum boards (in.)
12	11-1/8 ± 1/8
16	15-1/8 ± 1/8
19.2	18-1/4 ± 1/8

**Note:**  
Gypsum board lengths shown above provide at least 1/4" bearing on the top of the bottom flange in each I-joist as installed.

For SI: 1 inch = 25.4 mm

- (A) Floor sheathing: Materials and installation in accordance with 2021, 2018, 2015 and 2012 IRC Section R503.
  - (B) I-joist: Installation in accordance with Section 4.0 of this report. Maximum 19.2 inches on center spacing. Minimum flange size of 1 1/8 inches thick x 2 inches wide. Minimum web thickness of 3/8 inch. Adhesives used shall be as described in the quality manual approved by APA.
  - (C) 1-layer of 1/2-inch-thick gypsum board complying to ASTM C1396 provisions for gypsum wallboards, installed on the top of the bottom flange. Mechanical fastener or adhesive attachment to the top of the bottom flange is not required. A maximum gap of 5/16 inch between the edge of the gypsum and the I-joist web shall be permitted.
- Note: Penetrations or openings for ducts, vents, electrical outlets, lighting, devices, luminaires, wires, speakers, drainage, piping and similar openings or penetrations shall be permitted.

**FIGURE 9—FIRE PROTECTION: 1/2-INCH GYPSUM BOARD INSTALLED ON TOP OF THE BOTTOM FLANGE**

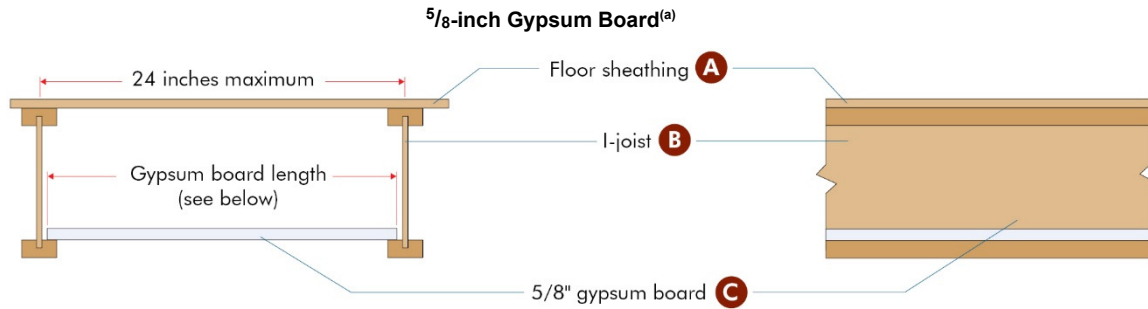

Joist spacing (in.)	Required length for gypsum boards (in.)
12	11-1/8 ± 1/8
16	15-1/8 ± 1/8
19.2	18-1/4 ± 1/8
24	23-1/8 ± 1/8

**Note:**

Gypsum board lengths shown above provide at least 1/4" bearing on the top of the bottom flange in each I-joist as installed.

For SI: 1 inch = 25.4 mm

- (A) Floor sheathing: Materials and installation in accordance with 2021, 2018, 2015 and 2012 IRC Section R503.
- (B) I-joist: Installation in accordance with Section 4.0 of this report. Maximum 24 inches on center spacing. Minimum flange size of 1 1/8 inches thick x 2 inches wide. Minimum web thickness of 3/8 inch. Adhesives used shall be as described in the quality manual approved by APA.
- (C) 1-layer of 5/8-inch-thick gypsum board complying to ASTM C1396 provisions for gypsum wallboards, installed on the top of the bottom flange. Mechanical fastener or adhesive attachment to the top of the bottom flange is not required. A maximum gap of 5/16 inch between the edge of the gypsum and the I-joist web shall be permitted.

Note: (a) Penetrations or openings for ducts, vents, electrical outlets, lighting, devices, luminaires, wires, speakers, drainage, piping and similar openings or penetrations shall be permitted.

**FIGURE 10—FIRE PROTECTION: 5/8-INCH GYPSUM BOARD INSTALLED ON TOP OF THE BOTTOM FLANGE**