

Fire-Rated Assemblies
Boise Cascade Wood Products, LLC

PR-S201
Revised June 28, 2024

Products: BCI[®] and AJS[®] I-Joists, and Versa-Lam[®] Rim Boards
Boise Cascade Wood Products, LLC, 1111 West Jefferson Street, Ste 300, Boise, ID 83702
(208) 384-6161
www.bc.com

1. Basis of the product report:
 - 2024 International Building Code (IBC): Sections 104.2.3 Alternative material, 703 Fire-Resistance Ratings and Fire Tests, 721 Prescriptive Fire Resistance, 722.6 Wood assemblies, and 2303.1.2 Prefabricated wood I-joists.
 - 2021, 2018, and 2015 IBC: Sections 104.11 Alternative materials, 703 Fire-Resistance Ratings and Fire Tests, 721 Prescriptive Fire Resistance, 722.6 Wood assemblies, and 2303.1.2 Prefabricated wood I-joists
 - 2024 International Residential Code (IRC): Sections R104.2.2 Alternative materials, R302.13 Fire protection of floors, and R502.1.2 and R802.1.7 Prefabricated wood I-joists.
 - 2021, 2018, and 2015 IRC: Sections R104.11 Alternative materials, R302.13 Fire protection of floors, R502.1.2 and R802.1.8 (2021 and 2018 IRC only) Prefabricated wood I-joists.
 - 2020 National Building Code of Canada (NBC): Clause 1.2.1.1 of Division A, Clauses 3.1.7, 4.1, 4.3.1.1, 9.10.3.1, 9.11, and 9.23.4.2 of Division B, Table 9.10.3.1.-B, and Appendix D
 - ASTM D5055-19e1, D5055-16, D5055-13e1, and D5055-13, recognized by the 2024 IBC and IRC, 2021 IBC and IRC, 2018 IBC and IRC, and 2015 IBC and IRC, respectively
 - American Wood Council Design for Code Acceptance DCA 3, Fire-Rated Wood-Frame Wall and Floor/Ceiling Assemblies
 - ICC-ES/APA Joint Evaluation Reports ESR-1040, ESR-1144, and ESR-1336
 - CCMC Evaluation Reports 12472-R, 12787-R, and 13300-R
 - APA Product Reports PR-L310
 - ASTM E119 and CAN/ULC S101 full-scale fire test reports, and engineering analyses
2. Product description:

The BCI[®] and AJS[®] I-joists covered by this report, as described in Tables 1 and 2, are made with laminated veneer lumber (LVL) or lumber flanges and OSB webs in accordance with the in-plant manufacturing standard approved by APA. The Versa-Lam[®] rim boards covered by this report are made with LVL in accordance with the in-plant manufacturing standard approved by APA.
3. Design properties:

Design properties for BCI and AJS I-joists are provided in ICC-ES/APA ESR-1144 and ESR-1336, and APA PR-L310 in the U.S., and CCMC 12787-R and 13300-R, and APA PR-L310C in Canada. Design properties for Versa-Lam rim boards are provided in ICC-ES/APA ESR-1040 in the U.S. and CCMC 12472-R in Canada.
4. Product installation:

BCI and AJS I-joists, and Versa-Lam rim boards covered by this report shall be installed in accordance with the recommendations provided by the manufacturer (www.bc.com/ewp). The rim board protection provided by the gypsum board as shown in Assemblies RB1 through RB6 in this report shall be continuous when the rim board is parallel to the floor joists. When the floor joists are perpendicular to the rim board, the gypsum board protection is permitted to be continuous or discontinuous. When the rim board protection is discontinuous due to interruption from the floor joists, the floor joists must abut the continuous rim board, and the required gypsum protection must abut the floor joists with

gaps of no greater than 1/16 inch. When the floor joists are I-joists, the gypsum protection must be notched to abut the I-joist flanges and web with gaps no greater than 1/16 inch, or the space between the I-joist web and the gypsum protection must be filled with a web filler attached to the web with a gap of no greater than 1/16 inch between the web filler and the I-joist flanges and between the gypsum protection and the web filler.

5. Fire-rated assemblies:
BCI and AJS Series I-joist, and Versa-Lam rim board assemblies have been shown through testing and engineering analysis to achieve the fire resistance ratings described in this report. Fire-rated assemblies with BCI and AJS I-joists, and Versa-Lam rim boards shall be constructed in accordance with the prescriptive requirements provided in this report or recommended by the manufacturer (see link above).
6. Fire-protection of floors:
BCI and AJS I-joists as described in Table 3, when installed and protected as specified in this report, meet the requirements of 2021, 2018, and 2015 IRC Section R302.13 and 2012 IRC Section R501.3, or are alternatives to the 2-by-10 dimension lumber prescribed in Exception 4 to 2021, 2018 and 2015 IRC Section R302.13 and 2012 IRC Section R501.3 with demonstrated equivalent fire performance.
7. Limitations:
 - a) BCI and AJS I-joists covered by this report shall be designed in accordance with the code using the design properties specified in ICC-ES/APA ESR-1144 and ESR-1336, and APA PR-L310 in the U.S., and CCMC 12787-R and 13300-R, and APA PR-L310C in Canada. Versa-Lam rim boards covered by this report shall be designed in accordance with the code using the design properties specified in ICC-ES/APA ESR-1040 in the U.S. and CCMC 12472-R in Canada.
 - b) BCI and AJS I-joists, and Versa-Lam rim boards covered in this report are limited to dry service conditions where the average equilibrium moisture content of sawn lumber is less than 16% in the U.S. and the average equilibrium moisture content of solid-sawn lumber over a year is 15% or less and does not exceed 19% in Canada.
 - c) BCI and AJS I-joists, and Versa-Lam rim boards covered in this report are permitted for use in fire-rated assemblies that meet the fire-resistance rating in accordance with the calculation method specified in NBC Appendix D-2.3.
 - d) BCI and AJS I-joists, and Versa-Lam rim boards covered by this report are produced at the Boise Cascade Wood Products' facilities in White City, Oregon, Lena, Louisiana, or St. Jacques, New Brunswick under a quality assurance program audited by APA.
 - e) This report is subject to re-examination in one year.
8. Identification:
BCI and AJS prefabricated wood I-joists, and Versa-Lam rim boards described in this report are identified by a label bearing the manufacturer's name (Boise Cascade Wood Products, LLC) and/or trademark, the APA assigned plant number (1109 for I-joists and 1110 for LVL manufactured in White City, Oregon, 1105 for I-joists and 1106 for LVL manufactured in Lena, Louisiana, and 1108 for I-joists manufactured in St. Jacques, New Brunswick), the product series, the APA logo, and a means of identifying the date of manufacture.

Table 1. Description of BCI Series I-Joists^(a)

Joist Series	Joist Depths (in.)	Flanges					Web	
		Material	Width (in.)	Depth (in.)			Material	Thickness (in.)
				XX00 Series	XX0 Series	XX Series		
BCI 40/400/4000 BCI 40S/400S/4000S	9-1/2 – 14	LVL	1-1/2	1-1/8	1-5/16	1-1/2	OSB	3/8
BCI 45/450/4500 BCI 45S/450S/4500S	9-1/2 – 16	LVL	1-3/4	1-1/8	1-5/16	1-1/2	OSB	3/8
BCI 50/500/5000 BCI 50S/500S/5000S	9-1/2 – 16	LVL	2	1-1/8	1-5/16	1-1/2	OSB	3/8
BCI 60/600/6000 BCI 60S/600S/6000S	9-1/2 – 20	LVL	2-5/16	1-1/8	1-5/16	1-1/2	OSB	3/8
BCI 65/650/6500 BCI 65S/650S/6500S	9-1/2 – 20	LVL	2-9/16	1-1/8	1-5/16	1-1/2	OSB	3/8
BCI 90/900/9000 BCI 90S/900S/9000S	9-1/2 – 20	LVL	3-1/2	1-1/8	1-5/16	1-1/2	OSB	3/8
BCI 90e	9-1/2 – 24	LVL	3-1/2	-	-	1-1/2	OSB	7/16

For SI: 1 inch = 25.4 mm.

^(a) Referenced dimensions are nominal. Tolerances are as specified in the plant quality manual.

Table 2. Description of AJS Series I-Joists^(a)

Joist Series	Joist Depths (in.)	Flanges			Web	
		Material	Dimension		Material	Thickness (in.)
			Depth (in.)	Width (in.)		
AJS-5	9-1/2 – 11-7/8	Proprietary SPF	1-1/2	2-1/2	OSB	3/8
AJS-10	9-1/2 – 16	Proprietary Spruce	1-1/2	2-1/2	OSB	3/8
AJS-20	9-1/4 – 16	MSR Lumber	1-1/2	2-1/2	OSB	3/8
AJS-20v	9-1/4 – 16	MSR Lumber	1-1/2	2-1/2	OSB	3/8
AJS-110	9-1/4 – 16	Proprietary SPF	1-1/2	2-1/2	OSB	3/8
AJS-140	9-1/4 – 16	Proprietary SPF	1-1/2	2-1/2	OSB	3/8
AJS-150	9-1/4 – 16	MSR Lumber	1-1/2	2-1/2	OSB	3/8
AJS-150v	9-1/4 – 16	MSR Lumber	1-1/2	2-1/2	OSB	3/8
AJS-160	9-1/2 – 16	MSR Lumber	1-1/2	2-1/2	OSB	3/8
AJS-170	9-1/2 – 16	MSR Lumber	1-1/2	2-1/2	OSB	3/8
AJS-180	9-1/2 – 16	MSR Lumber	1-1/2	2-1/2	OSB	3/8
AJS-190	9-1/4 – 16	MSR Lumber	1-1/2	2-1/2	OSB	3/8
	18 – 20					7/16
AJS-200	9-1/2 – 16	MSR Lumber	1-1/2	2-1/2	OSB	3/8
AJS-24	9-1/4 – 16	MSR Lumber	1-1/2	3-1/2	OSB	3/8
AJS-25	9-1/2 – 16	MSR Lumber	1-1/2	3-1/2	OSB	3/8
	18 – 24					7/16
AJS-25v	9-1/4 – 16	MSR Lumber	1-1/2	3-1/2	OSB	3/8
AJS-30	18 – 24	MSR Lumber	1-1/2	3-1/2	OSB	7/16

For SI: 1 inch = 25.4 mm.

^(a) Referenced dimensions are nominal. Tolerances are as specified in the plant quality manual.

Table 3. Applicable BCI and AJS Series I-joists that complies with Section 6 of this Report^(a)

Applicable Assemblies	Applicable Joist Series
FP-01	All BCI Joists; All AJS Joists
FP-02	BCI 50(S), 60(S), 65(S), 90(S), and 90e; All AJS Joists
FP-03	All BCI Joists except for BCI 40(S), 400(S), 4000(S) Joists; All AJS Joists
FP-04	All BCI Joists except for BCI 40(S), 400(S), 4000(S) Joists; All AJS Joists
FP-06	All BCI Joists except for BCI 40(S), 400(S), 4000(S), 45(S), 450(S), 4500(S) Joists; All AJS Joists
FP-07	All BCI Joists except for BCI 40(S), 400(S), 4000(S), 45(S), 450(S), 4500(S) Joists; All AJS Joists
FP-08	BCI 60(S), 65(S), 90(S), and 90e Joists; All AJS Joists
FP-09	All BCI Joists except for BCI 40(S), 400(S), 4000(S), 45(S), 450(S), 4500(S) Joists; All AJS Joists
FP-10	BCI 60(S), 65(S), 90(S), and 90e Joists; All AJS Joists
FP-11	BCI 65(S), 90(S), and 90e Joists; All AJS Joists
FP-12	All BCI Joists except for 40(S), 400(S), 4000(S), 45(S), 450(S), 4500(S), 50(S), 500(S), 5000(S) Joists; All AJS Joists

^(a) Minimum joist depth of 9-1/2 inches.



Boise Cascade Assembly FR1
45-Minute Fire Resistance Rated Floor and Roof Assembly
The following fire resistance design is listed in accordance with ASTM E119 and CAN/ULC S101

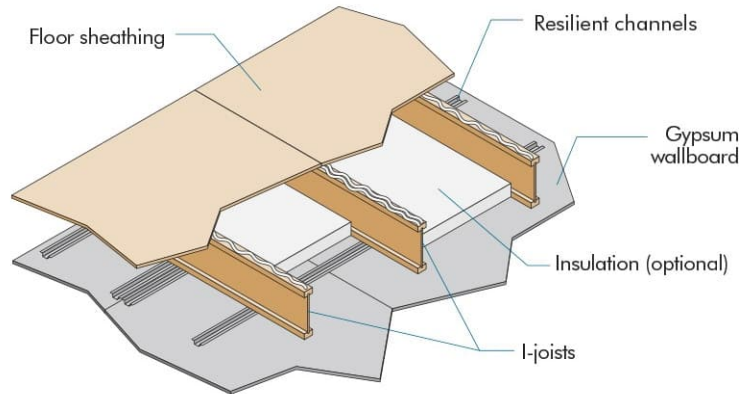

A. BASIC ASSEMBLIES

- 1) Floor Topping (Optional): Varies (reference sound ratings if applicable).
- 2) Floor Sheathing: Min. 23/32-inch (18-mm) T&G Wood Structural Panels. Min. 19/32-inch (15-mm) Wood Structural Panels are permitted when joists are spaced 20 inches (508 mm) or less and light weight concrete or proprietary topping is used. A construction adhesive must be applied to the top of the joists prior to placing sheathing. The sheets shall be installed with their long edge perpendicular to the joists with end joints centered over the top flange of joists and staggered one joist spacing with adjacent sheets. Floor sheathing must be installed per code requirements.
- 3) Insulation (Optional): Min. 3-1/2-inch (89-mm) Glass Fiber Insulation or 2-inch (51-mm) Rock Wool Insulation, 2.5 pcf nominal (reference sound ratings if applicable).
- 4) Structural Members: Min. 9-1/2-inch (241-mm) Deep I-Joists. Max. 24 inches (610 mm) on center spacing. Min. BCI flange dimensions of 1-1/8 inches (29 mm) thick by 2 inches (51 mm) wide. Min. AJS flange dimensions of 1-1/2 inches (38 mm) thick by 2-1/2 inches (64 mm) wide.
- 5) Resilient Channels: Min. 0.019-inch (0.5-mm) Galvanized Resilient Channels. Attached perpendicular to the bottom flange of the I-joist with 1-1/8-inch (29-mm) Type W drywall screws. Channels are spaced a max. of 16 inches (406 mm) on center. Additional channels required at gypsum wallboard end joints such that each board rests on its own channel. These additional channels shall extend to the next joist on each side of the board edges.
- 6) Ceiling: One layer of 5/8-inch (16-mm) Type C Gypsum Wallboard. Installed with long dimension perpendicular to resilient channels and fastened with min. 1-1/8-inch (29-mm) Type S drywall screws at 7 inches (178 mm) on center. The end joints of the wallboard must be staggered the equivalent of two joist spacings with those of adjacent sheets. Screws shall be min. 1-1/2 inches (38 mm) from board edge and 3/4 inch (19 mm) from board ends.
 - a) Finish: The face layer joints must be covered with tape and coated with joint compound. Screw heads must also be covered with joint compound.

B. SOUND RATINGS

Information not available

C. SIMILAR ASSEMBLIES

- 1) 2020 NBC Table 9.10.3.1.-B Assemblies F8, F10, F14, and F20.
- 2) Assemblies that meet the fire-resistance rating in accordance with NBC Table 9.10.3.1.-B or the calculation method specified in NBC Appendix D-2.3.

REPRESENTING THE ENGINEERED WOOD INDUSTRY



Boise Cascade Assembly FR2

One-Hour Fire Resistance Rated Floor and Roof Assembly

The following fire resistance design is listed in accordance with ASTM E119 and CAN/ULC S101

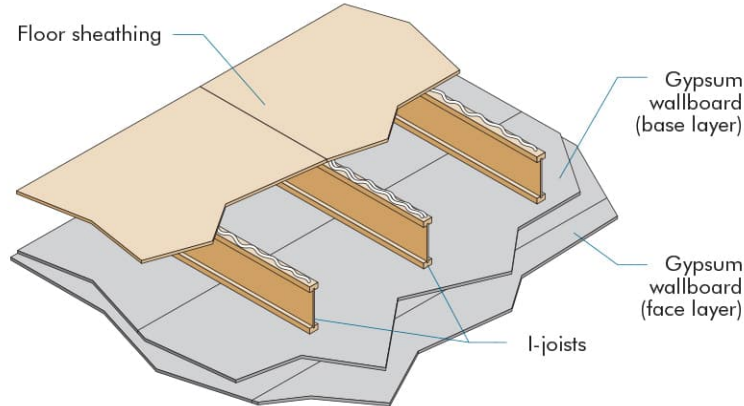

A. BASIC ASSEMBLIES

- 1) Floor Topping (Optional): Varies (reference sound ratings if applicable).
- 2) Floor Sheathing: Min. 23/32-inch (18-mm) T&G Wood Structural Panels. A construction adhesive must be applied to the top of the joists prior to placing sheathing. The sheets shall be installed with their long edge perpendicular to the joists with end joints centered over the top flange of joists and staggered one joist spacing with adjacent sheets. Floor sheathing must be installed per code requirements.
- 3) Insulation (Optional): Max. 9-1/2-inch (241-mm) Glass Fiber Insulation (reference sound ratings if applicable).
- 4) Structural Members: Min. 9-1/2 inches (241 mm) Deep I-Joists. Max. 24 inches (610 mm) on center spacing. Min. BCI flange dimensions of 1-1/8 inches (29 mm) thick by 1-1/2 inches (38 mm) wide. Min. AJS flange dimensions of 1-1/2 inches (38 mm) thick by 2-1/2 inches (64 mm) wide.
- 5) Resilient Channels (Optional): Min. 0.019-inch (0.5-mm) Galvanized Resilient Channels. Attached perpendicular to the bottom flange of the I-joist with 1-1/4-inch (32-mm) Type S drywall screws. Channels are spaced a max. of 16 inches (406 mm) or 24 inches (610 mm) on center when I-joists are spaced a max. of 16 inches (406 mm) on center.
- 6) Ceiling: Two layers of 5/8-inch (16-mm) Type X Gypsum Wallboard.
 - a) Base Layer: Install with long dimension perpendicular to joist length. Attach to the bottom flange of the joists using 1-1/4-inch (32-mm) Type W drywall screws at 24 inches (610 mm) on center. The end joints of the wallboard must be centered on the bottom flange of the joist and must be staggered the equivalent of two joist spacings with those of adjacent sheets.
 - b) Face Layer: Install with long dimension perpendicular to joist length. Attach to the bottom flange of the joists through the first layer using 1-7/8-inch (48-mm) Type W drywall screws spaced at 12 inches (305 mm) on center. The longitudinal joints of this layer must be offset 24 inches (610 mm) from those of the base layer. The end joints must be centered on the bottom flange of the joists and offset a min. of one joist spacing from those of the base layer. Additionally, face layer end joints are attached to the base layer with 1-1/2-inch (38-mm) Type G drywall screws at 12 inches (305 mm) on center placed 2 inches (51 mm) either side of the joint.
 - c) With Resilient Channels: Attached as described above except use 1-1/8-inch (29-mm) and 1-5/8-inch (41-mm) Type S screws for the base and face layer, respectively. The end joints of the wallboard must be centered on a resilient channel and must be staggered the equivalent of two joist spacings with those of adjacent sheets.
 - d) Finish: The face layer joints must be covered with tape and coated with joint compound. Screw heads must also be covered with joint compound.

B. SOUND RATING (with Resilient Channels)

Components	STC	IIC
Base Assembly with Carpet and Padding	54	68
Base Assembly with 3-1/2-inch (89-mm) Insulation	55	46
Base Assembly with additional layer of 5/8-inch (16-mm) Sheathing and 9-1/2-inch (241-mm) Insulation	61	50
Base Assembly with Tarkett "Acoustiflor" vinyl and 3-1/2-inch (89-mm) Insulation	59	50
Base Assembly with cushioned vinyl, 3/4-inch (19-mm) Gypsum Concrete and 3-1/2-inch (89-mm) Insulation	67	51

C. SIMILAR ASSEMBLIES

- 1) 2015/2018/2021/2024 IBC Table 721.1(3) Item 21-1.1, and 2020 NBC Table 9.10.3.1.-B Assemblies F4, F9, F11, F13, F15, F17, and F21 (also ICC-ES/APA ESR 1336 Figure 2 for BCI Joists).
- 2) Assemblies that meet the fire-resistance rating in accordance with NBC Table 9.10.3.1.-B or the calculation method specified in NBC Appendix D-2.3.

REPRESENTING THE ENGINEERED WOOD INDUSTRY



Boise Cascade Assembly FR2a

One-Hour Fire Resistance Rated Floor and Roof Assembly

The following fire resistance design is listed in accordance with ASTM E119 and CAN/ULC S101

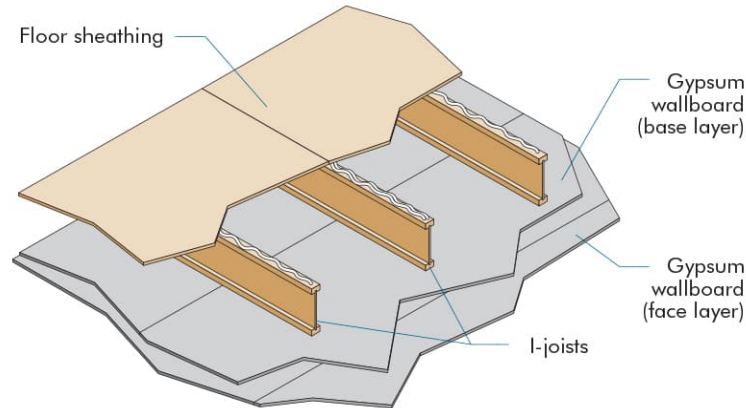

A. BASIC ASSEMBLIES

- 1) Floor Topping: Min. 1-1/2-inch (38-mm) Gypsum Concrete.
- 2) Floor Sheathing: Min. 19/32-inch (15-mm) T&G Wood Structural Panel. A construction adhesive must be applied to the top of the joists prior to placing sheathing. The sheets shall be installed with their long edge perpendicular to the joists with end joints centered over the top flange of joists and staggered one joist spacing with adjacent sheets. Floor sheathing must be installed per code requirements.
- 3) Insulation (Optional): Max. 9-1/2-inch (241-mm) Glass Fiber Insulation (reference sound ratings if applicable).
- 4) Structural Members: Min. 9-1/2 inches (241 mm) Deep I-Joists. Max. 16 inches (406 mm) on center spacing. Min. BCI flange dimensions of 1-1/8 inches (29 mm) thick by 1-1/2 inches (38 mm) wide. Min. AJS flange dimensions of 1-1/2 inches (38 mm) thick by 2-1/2 inches (64 mm) wide.
- 5) Resilient Channels (Optional): Min. 0.019-inch (0.5-mm) Galvanized Resilient Channels. Attached perpendicular to the bottom flange of the I-joist with 1-1/4-inch (32-mm) Type S drywall screws. Channels are spaced a max. of 16 inches (406 mm) or 24 inches (610 mm) on center when I-joists are spaced a max. of 16 inches on center.
- 6) Ceiling: Two layers of 5/8-inch (16-mm) Type X Gypsum Wallboard.
 - a) Base Layer: Install with long dimension perpendicular to joist length. Attach to the bottom flange of the joists using 1-1/4-inch (32-mm) Type W drywall screws at 24 inches (610 mm) on center. The end joints of the wallboard must be centered on the bottom flange of the joist and must be staggered the equivalent of two joist spacings with those of adjacent sheets.
 - b) Face Layer: Install with long dimension perpendicular to joist length. Attach to the bottom flange of the joists through the first layer using 1-7/8-inch (48-mm) Type W drywall screws spaced at 12 inches (305 mm) on center. The longitudinal joints of this layer must be offset 24 inches (610 mm) from those of the base layer. The end joints must be centered on the bottom flange of the joists and offset a min. of one joist spacing from those of the base layer. Additionally, face layer end joints are attached to the base layer with 1-1/2-inch (38-mm) Type G drywall screws at 12 inches (305 mm) on center placed 2 inches (51 mm) either side of the joint.
 - c) With Resilient Channels: Attached as described above except use 1-1/8-inch (29-mm) and 1-5/8-inch (41-mm) Type S screws for the base and face layer, respectively. The end joints of the wallboard must be centered on a resilient channel and must be staggered the equivalent of two joist spacings with those of adjacent sheets.
 - d) Finish: The face layer joints must be covered with tape and coated with joint compound. Screw heads must also be covered with joint compound.

B. SOUND RATING (with Resilient Channels)

Components	STC	IIC
Base Assembly with Carpet and Padding	54	68
Base Assembly with 3-1/2-inch (89-mm) Insulation	55	46
Base Assembly with additional layer of 5/8-inch (16-mm) Sheathing and 9-1/2-inch (241-mm) Insulation	61	50
Base Assembly with Tarkett "Acoustiflor" vinyl and 3-1/2-inch (89-mm) Insulation	59	50
Base Assembly with cushioned vinyl, 3/4-inch (19-mm) Gypsum Concrete and 3-1/2-inch (89-mm) Insulation	67	51

C. SIMILAR ASSEMBLIES

- 1) Assemblies that meet the fire-resistance rating in accordance with NBC Table 9.10.3.1.-B or the calculation method specified in NBC Appendix D-2.3.

REPRESENTING THE ENGINEERED WOOD INDUSTRY



Boise Cascade Assembly FR3

One-Hour Fire Resistance Rated Floor and Roof Assembly

The following fire resistance design is listed in accordance with ASTM E119 and CAN/ULC S101

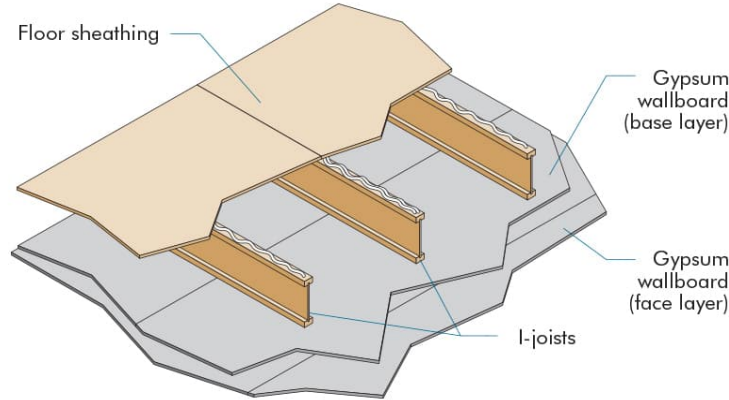

A. BASIC ASSEMBLIES

- 1) Floor Topping (Optional): Varies (reference sound ratings if applicable).
- 2) Floor Sheathing: Min. 23/32-inch (18-mm) T&G Wood Structural Panel. A construction adhesive must be applied to the top of the joists prior to placing sheathing. The sheets shall be installed with their long edge perpendicular to the joists with end joints centered over the top flange of joists and staggered one joist spacing with adjacent sheets. Floor sheathing must be installed per code requirements.
- 3) Insulation (Optional): Max. 9-1/2-inch (241-mm) Glass Fiber Insulation (reference sound ratings if applicable).
- 4) Structural Members: Min. 9-1/2 inches (241 mm) Deep I-Joists. Max. 24 inches (610 mm) on center spacing. Min. BCI flange dimensions of 1-1/8 inches (29 mm) thick by 1-1/2 inches (38 mm) wide. Min. AJS flange dimensions of 1-1/2 inches (38 mm) thick by 2-1/2 inches (64 mm) wide. Min. web thickness of 3/8 inch (9.5 mm).
- 5) Resilient Channels (Optional): Min. 0.019-inch (0.5-mm) Galvanized Resilient Channels. Attached perpendicular to the bottom flange of the I-joist with 1-1/4-inch (32-mm) Type S drywall screws. Channels are spaced a max. of 16 inches (406 mm) or 24 inches (610 mm) on center when I-joists are spaced a max. of 16 inches on center.
- 6) Ceiling: Two layers of 1/2-inch (13-mm) Type C Gypsum Wallboard.
 - a) Base Layer: Install with long dimension perpendicular to joist length. Attach to the bottom flange of the joists using 1-1/4-inch (32-mm) Type W drywall screws at 12 inches (305 mm) on center. The end joints of the wallboard must be centered on the bottom flange of the joist and must be staggered the equivalent of two joist spacings with those of adjacent sheets.
 - b) Face Layer: Install with long dimension perpendicular to joist length. Attach to the bottom flange of the joists through the first layer using 1-5/8-inch (41-mm) Type W drywall screws spaced at 12 inches (305 mm) on center on intermediate joists and 6 inches (152 mm) on center at end joints. The longitudinal joints of this layer must be offset 24 inches (610 mm) from those of the base layer. The end joints must be centered on the bottom flange of the joists and offset a min. of one joist spacing from those of the base layer. Additionally, face layer end joints are attached to the base layer with 1-1/2-inch (38-mm) Type G drywall screws at 12 inches (305 mm) on center placed 1-3/4 inches (44 mm) either side of the joint.
 - c) With Resilient Channels: Attached as described above except use 1-inch (25-mm) and 1-5/8-inch (41-mm) Type S screws for the base and face layer, respectively. The end joints of the wallboard must be centered on a resilient channel and must be staggered the equivalent of two joist spacings with those of adjacent sheets.
 - d) Finish: The face layer joints must be covered with tape and coated with joint compound. Screw heads must also be covered with joint compound.

B. SOUND RATING (with Resilient Channels)

Components	STC	IIC
Base Assembly with Carpet and Padding	54	68
Base Assembly with 3-1/2-inch (89-mm) Insulation	55	46
Base Assembly with additional layer of 5/8-inch (16-mm) Sheathing and 9-1/2-inch (241-mm) Insulation	61	50
Base Assembly with Tarkett "Acoustiflor" vinyl and 3-1/2-inch (89-mm) Insulation	59	50
Base Assembly with cushioned vinyl, 3/4-inch (19-mm) Gypsum Concrete and 3-1/2-inch (89-mm) Insulation	67	51

C. SIMILAR ASSEMBLIES

- 1) 2015/2018/2021/2024 IBC Table 721.1(3) Items 26-1.1 and 27-1.1, and 2020 NBC Table 9.10.3.1.-B Assemblies F4, F9, F11, F13, F15, F17, and F21 (also ICC-ES/APA ESR 1336 Figure 3 for BCI Joists).
- 2) Assemblies that meet the fire-resistance rating in accordance with NBC Table 9.10.3.1.-B or the calculation method specified in NBC Appendix D-2.3.

REPRESENTING THE ENGINEERED WOOD INDUSTRY



Boise Cascade Assembly FR4
One-Hour Fire Resistance Rated Floor and Roof Assembly
 The following fire resistance design is listed in accordance with ASTM E119 and CAN/ULC S101

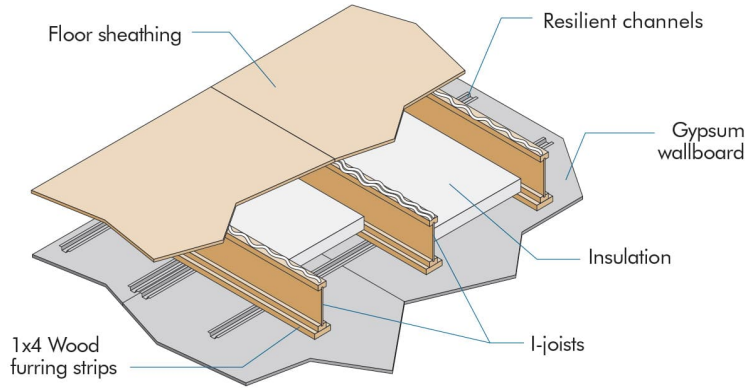

A. BASIC ASSEMBLIES

- 1) Floor Topping (Optional): Varies (reference sound ratings if applicable).
- 2) Floor Sheathing: Min. 23/32-inch (18-mm) T&G Wood Structural Panel. A construction adhesive must be applied to the top of the joists prior to placing sheathing. The sheets shall be installed with their long edge perpendicular to the joists with end joints centered over the top flange of joists and staggered one joist spacing with adjacent sheets. Floor sheathing must be installed per code requirements.
- 3) Insulation: Min. 2-inch (51-mm) Mineral Fiber Insulation, Min. 3.5 pcf. Installed adjacent to the bottom flange of the I-joist and supported by 1x4 furring strips. The ends of the batts must be centered over resilient channels.
- 4) Structural Members: Min. 9-1/4 inches (235 mm) Deep I-Joists. Max. 24 inches (610 mm) on center spacing. Min. flange dimensions of 1-5/16 inches (33 mm) thick by 1-3/4 inches (44mm) wide. Min. web thickness of 3/8 inch (9.5 mm).
- 5) Furring Strips: 1x4 (nominal) Wood Furring Strips centered on the bottom flange of the I-joist and attached with 1-1/2-inch (38-mm) Type W screws at 24 inches (610 mm) on center.
- 6) Resilient Channels: Min. 0.019-inch (0.5-mm) Galvanized Resilient Channels. Attached perpendicular to the bottom flange of the I-joist with 1-7/8-inch (48-mm) Type S drywall screws. Channels are spaced a maximum of 16 inches (406 mm) on center and doubled at each wallboard end joint extending to the next joist beyond each joint.
- 7) Ceiling: One layer of 5/8-inch (16-mm) Type C Gypsum Wallboard. Installed with long dimension perpendicular to resilient channels and fastened with minimum 1-1/8-inch (29-mm) Type S drywall screws at 7 inches (178 mm) on center. The end joints of the wallboard must be staggered the equivalent of two joist spacings with those of adjacent sheets.
 - a) Finish: The face layer joints must be covered with tape and coated with joint compound. Screw heads must also be covered with joint compound.

B. SOUND RATING

Components	STC	IIC
Base Assembly with Carpet and Padding	52	66
Base Assembly with cushioned vinyl, 3/4-inch (19-mm) Gypsum Concrete	55	49
Base Assembly with cushioned vinyl, 1-inch (25-mm) Gypsum Concrete, 1/4-inch (6-mm) Acousti-Mat II	58	57

C. SIMILAR ASSEMBLIES

- 1) 2015/2018/2021/2024 IBC Table 721.1(3) Item 23-1.1 (also ICC-ES/APA ESR 1336, Figure 4 for BCI Joists and DCA 3 WIJ-1.3).
- 2) Assemblies that meet the fire-resistance rating in accordance with NBC Table 9.10.3.1.-B or the calculation method specified in NBC Appendix D-2.3.

REPRESENTING THE ENGINEERED WOOD INDUSTRY



Boise Cascade Assembly FR5
One-Hour Fire Resistance Rated Floor and Roof Assembly*
The following fire resistance design is listed in accordance with ASTM E119 and CAN/ULC S101

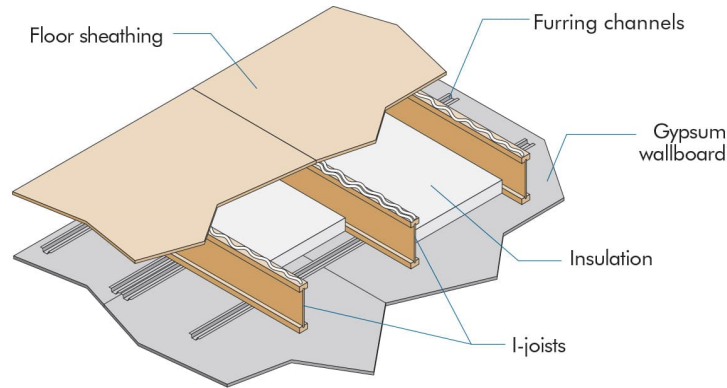

A. BASIC ASSEMBLIES

- 1) Floor Topping (Optional): Varies (reference sound ratings if applicable).
- 2) Floor Sheathing: Min. 23/32-inch (18-mm) T&G Wood Structural Panel. A construction adhesive must be applied to the top of the joists prior to placing sheathing. The sheets shall be installed with their long edge perpendicular to the joists with end joints centered over the top flange of joists and staggered one joist spacing with adjacent sheets. Floor sheathing must be installed per code requirements.
- 3) Insulation: Min. 1-1/2-inch (38-mm) Mineral Fiber Insulation, Min. 2.8 pcf. Installed adjacent to the bottom flange of the I-joist and supported by the furring channels. Ends of bats shall be centered over resilient channels.
- 4) Structural Members: Min. 9-1/2 inches (241 mm) Deep I-Joists. Max. 24 inch (610 mm) on center spacing. Min. flange dimensions of 1-1/2 inches (38 mm) thick by 3-1/2 inches (89 mm) wide. Min. web thickness of 3/8 inch (9.5 mm).
- 5) Furring Channels: Min. 0.026-inch (0.66-mm) Hat Shaped Galvanized Steel Channels attached perpendicular to the bottom flange of the I-joist with 1-5/8-inch (41-mm) Type S drywall screws. Channels are spaced a max. of 16 inches (406 mm) on center and doubled at each wallboard end joint extending to the next joist beyond each joint.
- 6) Ceiling: One layer of 5/8-inch (16-mm) Type C Gypsum Wallboard. Installed with long dimension perpendicular to resilient channels and fastened with min. 1-1/8-inch (29-mm) Type S drywall screws spaced at 12 inches (305 mm) on center on intermediate joists and 8 inches (203 mm) on center at end joints. The end joints of the wallboard must be staggered the equivalent of two joist spacings with those of adjacent sheets.
 - a) Finish: The face layer joints must be covered with tape and coated with joint compound. Screw heads must also be covered with joint compound.

B. SIMILAR ASSEMBLIES

- 1) BCI 90 Joists: 2015/2018/2021/2024 IBC Table 721.1(3) Item 24-1.1, and DCA 3 WIJ-1.1.
- 2) AJS 25/30 Joists: 2015/2018/2021/2024 IBC Table 721.1(3) Item 24-1.1, and DCA 3 WIJ-1.1.
- 3) Assemblies that meet the fire-resistance rating in accordance with NBC Table 9.10.3.1.-B or the calculation method specified in NBC Appendix D-2.3.

* This assembly may also be used in a fire-rated roof/ceiling assembly, but only when constructed exactly as described.

REPRESENTING THE ENGINEERED WOOD INDUSTRY



Boise Cascade Assembly FR6
One-Hour Fire Resistance Rated Floor and Roof Assembly*
 The following fire resistance design is listed in accordance with ASTM E119 and CAN/ULC S101

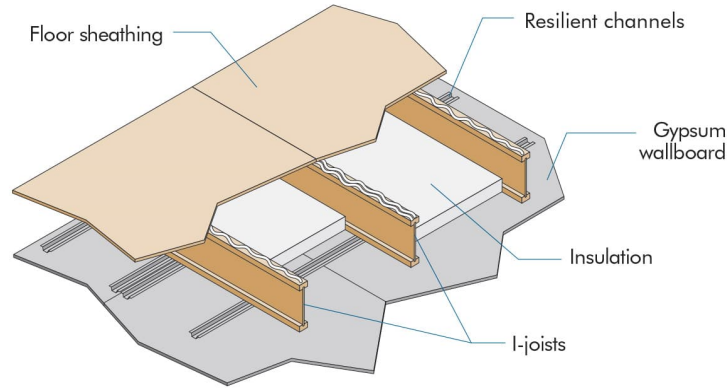

A. BASIC ASSEMBLIES

- 1) Floor Topping (Optional): Varies (reference sound ratings if applicable).
- 2) Floor Sheathing: Min. 23/32-inch (18-mm) T&G Wood Structural Panel. A construction adhesive must be applied to the top of the joists prior to placing sheathing. The sheets shall be installed with their long edge perpendicular to the joists with end joints centered over the top flange of joists and staggered one joist spacing with adjacent sheets. Floor sheathing must be installed per code requirements.
- 3) Insulation: Min. 1-1/2-inch (38-mm) Mineral Fiber Insulation, Min. 2.8 pcf. Installed adjacent to the bottom flange of the I-joist and supported by the furring channels. The ends of the batts shall be centered over resilient channels.
- 4) Structural Members: Min. 9-1/2 inches (241 mm) Deep I-Joists. Max. 24 inches (610 mm) on center spacing. Min. flange dimensions of 1-1/2 inches (38 mm) thick by 3-1/2 inches (89 mm) wide. Min. web thickness of 3/8 inch (9.5 mm).
- 5) Resilient Channels: Min. 0.019-inch (0.5-mm) Galvanized Resilient Channels. Attached perpendicular to the bottom flange of the I-joist with 1-5/8-inch (41-mm) Type S drywall screws. Channels are spaced a max. of 16 inches (406 mm) on center and doubled at each wallboard end joint extending to the next joist beyond each joint.
- 6) Ceiling: One layer of 5/8-inch (16-mm) Type C Gypsum Wallboard. Installed with long dimension perpendicular to resilient channels and fastened with min. 1-1/8-inch (29-mm) Type S drywall screws spaced at 12 inches (305 mm) on center on intermediate joists and 8 inches (203 mm) on center at end joints. The end joints of the wallboard must be staggered the equivalent of two joist spacings with those of adjacent sheets.
 - a) Finish: The face layer joints must be covered with tape and coated with joint compound. Screw heads must also be covered with joint compound.

B. SOUND RATING^(a,b)

Joist/RC Spacing ^(c)	Without Gypsum Concrete				With 1-in. (25-mm) Gypsum Concrete			
	Cushioned Vinyl		Carpet & Pad		Cushioned Vinyl		Carpet & Pad	
	STC	IIC	STC	IIC	STC	IIC	STC	IIC
24"/16" o.c.	48 (51)	42 (43)	48 (51)	61 (63)	63 (65)	50 (52)	63 (65)	65 (67)
16"/16" o.c.	44 (46)	37 (39)	44 (46)	60 (61)	56 (57)	46 (47)	56 (57)	58 (59)

^(a) Sound ratings from the American Wood Council publication Design for Code Acceptance (DCA) 3, available from www.awc.org.

^(b) STC and IIC values established by engineering analysis based on 1.5-in. (38-mm) thick mineral wool batt insulation. Values in parentheses are based on 3.5-in. (89-mm) thick mineral wool batt insulation.

^(c) STC and IIC values for 16 in. (406 mm) o.c. joist spacing are applicable to 19.2-in. (488 mm) o.c. joist spacing.

C. SIMILAR ASSEMBLIES

- 1) BCI 90 Joists: 2015/2018/2021/2024 IBC Table 721.1(3) Item 25-1.1, 2020 NBC Table 9.10.3.1.-B Assemblies F10, F14, and F20, DCA 3 WIJ-1.2, and ICC-ES/APA ESR 1336 Figure 5.
- 2) AJS 25/30 Joists: 2015/2018/2021/2024 IBC Table 721.1(3) Item 25-1.1, 2020 NBC Table 9.10.3.1.-B Assemblies F10, F14, and F20, and DCA 3 WIJ-1.2.
- 3) Assemblies that meet the fire-resistance rating in accordance with NBC Table 9.10.3.1.-B or the calculation method specified in NBC Appendix D-2.3.

* This assembly may also be used in a fire-rated roof/ceiling assembly, but only when constructed exactly as described.

REPRESENTING THE ENGINEERED WOOD INDUSTRY



Boise Cascade Assembly FR7

One-Hour Fire Resistance Rated Floor and Roof Assembly

The following fire resistance design is listed in accordance with ASTM E119 and CAN/ULC S101

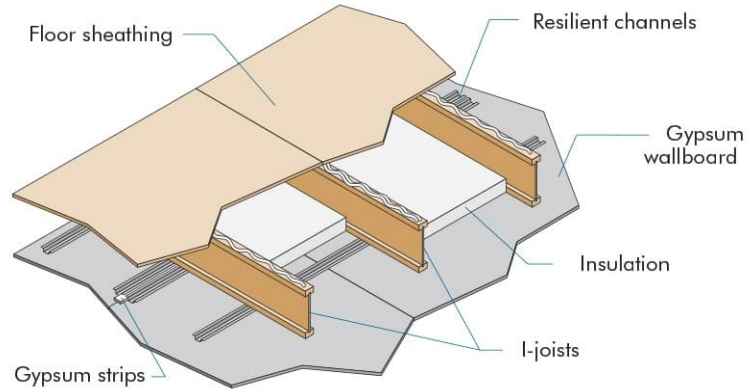

A. BASIC ASSEMBLIES

- 1) Floor Topping (Optional): Varies (reference sound ratings if applicable).
- 2) Floor Sheathing: Min. 23/32-inch (18-mm) T&G Wood Structural Panel. A construction adhesive must be applied to the top of the joists prior to placing sheathing. The sheets shall be installed with their long edge perpendicular to the joists with end joints centered over the top flange of joists and staggered one joist spacing with adjacent sheets. Floor sheathing must be installed per code requirements.
- 3) Insulation: Min. 2-inch (51-mm) Mineral Fiber Insulation, Min. 3.5 pcf. Installed adjacent to the bottom flange of the I-joist and supported by the furring channels. The ends of the batts shall be centered over resilient channels.
- 4) Structural Members: Min. 9-1/2 inches (241 mm) Deep I-Joists. Max. 24 inches (610 mm) on center spacing. Min. flange dimensions of 1-5/16 inches (33 mm) thick by 3-1/2 inches (89 mm) wide. Min. web thickness of 3/8 inch (9.5 mm).
- 5) Resilient Channels: Min. 0.019-inch (0.5-mm) Galvanized Resilient Channels. Attached perpendicular to the bottom flange of the I-joist with 1-1/4-inch (32-mm) Type W drywall screws. Channels are spaced a max. of 16 inches (406 mm) on center and doubled at each wallboard end joint extending to the next joist beyond each joint.
- 6) Gypsum Strips: 2 inches (51 mm) wide by 1/2 inch (13 mm) Type C Gypsum Wallboard. Installed perpendicular to the I-joists above each end joint of the 5/8-inch (16-mm) gypsum wallboard. The strips are attached with one 1-1/4-inch (32-mm) Type W drywall screw at each joist.
- 7) Ceiling: One layer of 5/8-inch (16-mm) Type C Gypsum Wallboard. Installed with long dimension perpendicular to resilient channels and fastened with min. 1-1/8-inch (29-mm) Type S drywall screws spaced at 8 inches (203 mm) on center. The end joints of the wallboard must be staggered the equivalent of two joist spacings with those of adjacent sheets.
 - a) Finish: The face layer joints must be covered with tape and coated with joint compound. Screw heads must also be covered with joint compound.

B. SOUND RATING

Components	STC	IIC
Base Assembly with Carpet and Padding	55	62
Base Assembly with cushioned vinyl, 3/4-inch (19-mm) Gypsum Concrete	58	45
Base Assembly with cushioned vinyl, 1-inch (25-mm) Gypsum Concrete, 1/4-inch (6-mm) Acousti-Mat II	61	53

C. SIMILAR ASSEMBLIES

- 1) BCI 90 Joists: ICC-ES/APA ESR 1336 Figure 6.
- 2) Assemblies that meet the fire-resistance rating in accordance with NBC Table 9.10.3.1.-B or the calculation method specified in NBC Appendix D-2.3.

REPRESENTING THE ENGINEERED WOOD INDUSTRY



Boise Cascade Assembly FR8
One-Hour Fire Resistance Rated Floor and Roof Assembly* †
 This fire resistance design is listed in accordance with the ASTM E119 and CAN/ULC S101

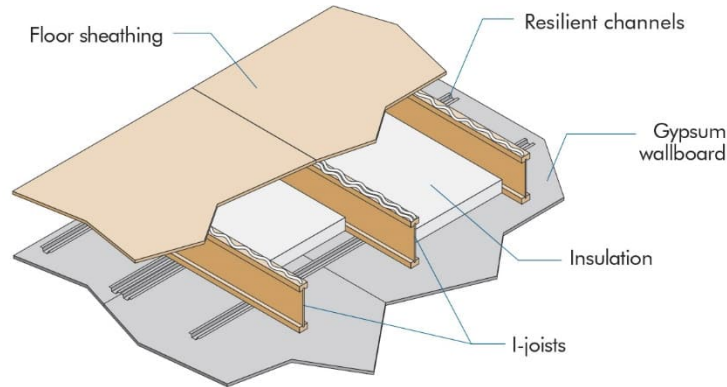

A. BASIC ASSEMBLIES

- 1) Floor Topping (Optional): Varies (reference sound ratings if applicable).
- 2) Floor Sheathing: Min. 23/32-inch (18-mm) T&G Wood Structural Panel. A construction adhesive must be applied to the top of the joists prior to placing sheathing. The sheets shall be installed with their long edge perpendicular to the joists with end joints centered over the top flange of joists. Floor sheathing must be installed per code requirements.
- 3) Insulation: Min. 3-1/2-inch (89-mm) Fiber Glass Insulation (R13). Installed adjacent to the bottom flange of the I-joist and supported by the resilient channels.
- 4) Structural Members: Min. 9-1/2-inch (241-mm) Deep I-Joists. Max. 24 inches (610 mm) on center spacing. Min. flange thickness of 1-1/2 inches (38 mm) and each flange area of at least 3.75 inches² (2,419 mm²). Min. web thickness of 3/8 inch (9.5 mm).
- 5) Resilient Channels: Min. 0.019-inch (0.5-mm) Galvanized Resilient Channels. Attached perpendicular to the bottom flange of the I-joist with 1-1/4-inch (32-mm) Type W drywall screws. Channels are spaced a max. of 16 inches (406 mm) on center, are doubled at each wallboard end joint, and extend to the next joist beyond each joint.
- 6) Ceiling: One layer of 3/4-inch (19-mm) Type X Gypsum Wallboard with a minimum weight of 3.0 lbf/ft² (14.6 kg/m²) in compliance with ASTM C1396. Installed with long dimension perpendicular to resilient channels and fastened with min. 1-1/8-inch (29-mm) Type S drywall screws spaced at 8 inches (203 mm) on center, and 1 inch (25 mm) from wallboard edges and 1-1/2 inches (38 mm) from wallboard ends. The end joints of the wallboard must be staggered.
 - a) Finish: The face joints must be covered with tape and coated with joint compound. Screw heads must also be covered with joint compound.

B. SOUND RATING^(a)

Components	STC	IIC
Base Assembly with cushioned vinyl	52	44
Base Assembly with Carpet and Padding	52	64
Base Assembly with cushioned vinyl, Gypsum Concrete	64	53
Base Assembly with Carpet and Padding, Gypsum Concrete	64	68

^(a) Sound ratings determined from engineering analysis using AWC Technical Report 15, Calculation of Sound Transmission Parameters for Wood-Frame Assemblies in accordance with Section 1206.2 of the 2024/2021/2018 IBC.

C. SIMILAR ASSEMBLIES

- 1) Assemblies that meet the fire-resistance rating in accordance with NBC Table 9.10.3.1.-B or the calculation method specified in NBC Appendix D-2.3.

* This assembly may also be used in a fire-rated roof/ceiling assembly, but only when constructed exactly as described.

† Authorization for use by APA – The Engineered Wood Association.

REPRESENTING THE ENGINEERED WOOD INDUSTRY



Boise Cascade Assembly FR9
Two-Hour Fire Resistance Rated Floor and Roof Assembly*
The following fire resistance design is listed in accordance with ASTM E119 and CAN/ULC S101

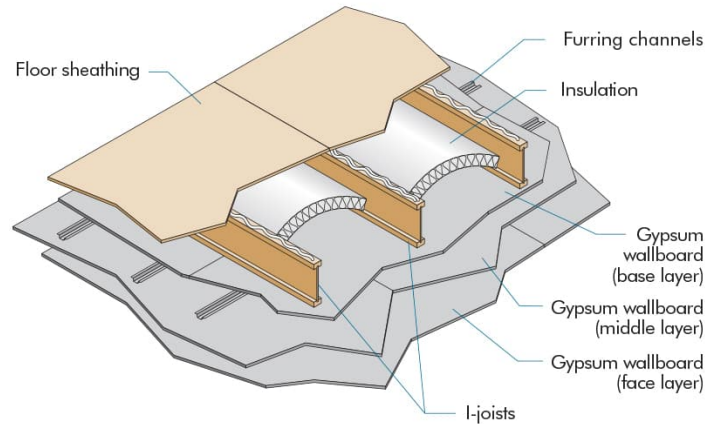

A. BASIC ASSEMBLIES

- 1) Floor Topping (Optional): Varies (reference sound ratings if applicable).
- 2) Floor Sheathing: Min. 23/32-inch (18-mm) T&G Wood Structural Panel. A construction adhesive must be applied to the top of the joists prior to placing sheathing. The sheets shall be installed with their long edge perpendicular to the joists with end joints centered over the top flange of joists and staggered one joist spacing with adjacent sheets. Floor sheathing must be installed per code requirements.
- 3) Insulation: Max. 3-1/2-inch (89-mm) Unfaced Glass Fiber Insulation. Friction fitted between I-joists and supported by stay wires spaced 12 inches (305 mm) on center along the top of the I-joint bottom flange.
- 4) Structural Members: Min. 9-1/2 inches (241 mm) Deep I-Joists. Max. 24 inches (610 mm) on center spacing. Min. BCI flange dimensions of 1-1/8 inches (29 mm) thick by 2 inches (51 mm) wide. Min. AJS flange dimensions of 1-1/2 inches (38 mm) thick by 2-1/2 inches (64 mm) wide. Min. web thickness of 3/8 inch (9.5 mm).
- 5) Furring Channels: Min. 0.019-inch (0.5-mm) Hat Shaped Galvanized Steel Channels attached perpendicular to the bottom flange of the I-joint with 1-5/8-inch (41-mm) Type S drywall screws penetrating through the wallboard base layer into each I-joint flange. Channels are spaced a max. of 16 inches (406 mm) on center and doubled at each wallboard end joint extending to the next joist beyond each joint.
- 6) Ceiling: Three layers of 5/8-inch (16-mm) Type C Gypsum Wallboard.
 - a) Base Layer: Install with long dimension perpendicular to joist length. Attach to the bottom flange of the joists using 1-5/8-inch (41-mm) Type S drywall screws at 12 inches (305 mm) on center. The end joints of the wallboard must be centered on the bottom flange of the I-joint and must be staggered the equivalent of two joist spacings with those of adjacent sheets.
 - b) Middle Layer: Attached to furring channels using 1-inch (25-mm) Type S drywall screws at 12 inches (305 mm) on center with the long dimension perpendicular to furring channels. End joints must be staggered from end joints of adjacent sheets and end joints on the face layer.
 - c) Face Layer: Attached to furring channels through the middle layer using 1-5/8-inch (41-mm) Type S drywall screws spaced at 8 inches (203 mm) on center with long dimension perpendicular to furring channel. End joints must be staggered from end joints of adjacent sheets and staggered 32 inches (813 mm) from end joints on the middle layer. Edge joints (long dimension) must be offset 24 inches (610 mm) from those of the middle layer.
 - d) Finish: The face layer joints must be covered with tape and coated with joint compound. Screw heads must also be covered with joint compound.

B. SIMILAR ASSEMBLIES

- 1) 2015/2018/2021/2024 IBC Table 721.1(3) Item 28-1.1, and DCA 3 WIJ-2.1 (also ICC-ES/APA ESR 1336 Figure 7 for BCI Joists).
- 2) Assemblies that meet the fire-resistance rating in accordance with NBC Table 9.10.3.1.-B or the calculation method specified in NBC Appendix D-2.3.

* This assembly may also be used in a fire-rated roof/ceiling assembly, but only when constructed exactly as described.

REPRESENTING THE ENGINEERED WOOD INDUSTRY



Fire Protection of Floors (FP-01) for Compliance with 2012 IRC Section R501.3 and 2015/2018/2021 IRC Section R302.13

Fire Protection: 1/2-inch Gypsum Board or 5/8-inch Wood Structural Panels Attached to Bottom of Flange
The following fire resistance design is in compliance with 2012 IRC Section R501.3 and 2015/2018/2021 IRC Section R302.13
All BCI Joists; All AJS Joists

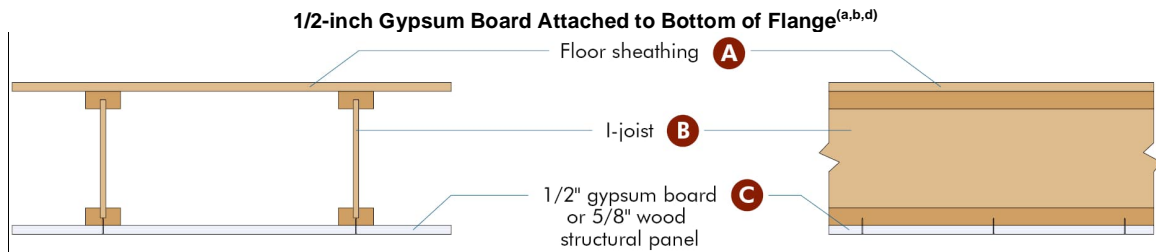

Crawl Space Exception^(b)

In accordance with Exception 2 of the 2012 IRC Section R501.3 and 2015/2018/2021 IRC Section R302.13, floor assemblies located directly over a crawl space not intended for storage or fuel-fired appliances do not require membrane protection.

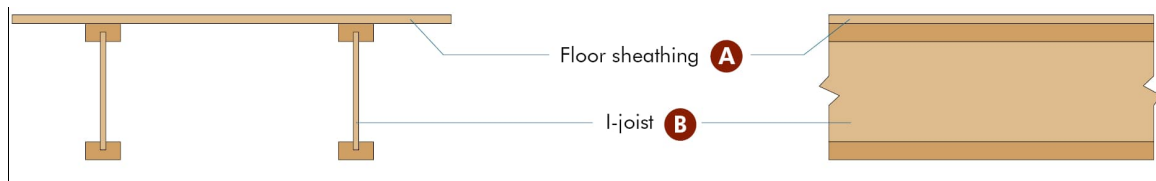

Automatic Sprinkler Exception^(c)

In accordance with Exception 1 of the 2012 IRC Section R501.3 and 2015/2018/2021 IRC Section R302.13, floor assemblies located directly over a space protected by an automatic sprinkler system do not require membrane protection.

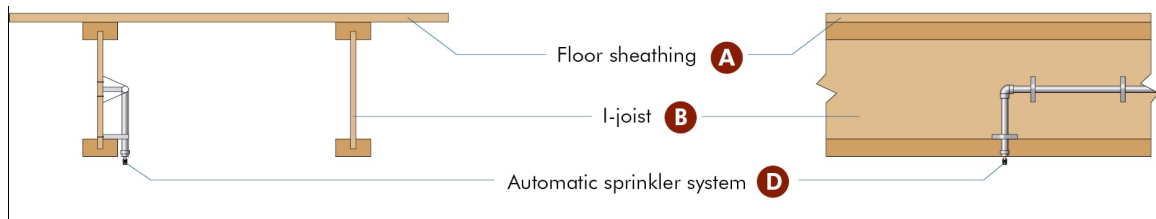

- (A) Floor sheathing: Materials and installation in accordance with 2012, 2015, 2018, and 2021 IRC Section R503.
- (B) I-joist: Installation in accordance with Section 4.0 of this report. Max. 24 inches on center spacing. Applicable to all flange sizes. Minimum web thickness of 3/8 inch. Adhesives used shall be as described in the quality manual approved by APA.
- (C) 1/2-inch gypsum board: Materials and installation in accordance with 2012, 2015, 2018, and 2021 IRC Section R702.3.1 or equivalent. 1x3 (nominal) wood furring strips are permitted to be installed perpendicular to the bottom flange of the I-joists at 16 inches on center provided that the gypsum boards are directly attached to the furring strips using 1-1/4-inch (32-mm) Type W drywall screws at 12 inches (305 mm) on center. Gypsum board not required to be finished with tape and joint compound; or 5/8-inch wood structural panel: Materials and installation in accordance with 2012, 2015, 2018, and 2021 IRC Section R503.2 or equivalent. Wood structural panel not required to be finished with wood filler or sanded.
- (D) Automatic sprinkler system: System in accordance with Section P2904 of the 2012, 2015, 2018, and 2021 IRC, NFPA 13D, or other equivalent sprinkler systems.

Notes:

- (a) In accordance with Exception 3 of the 2012 IRC Section R501.3 and 2015/2018/2021 IRC Section R302.13, portions of floor assembly can be unprotected when complying with the following:
 - 1) The aggregate area of the unprotected portions shall not exceed 80 square feet.
 - 2) Fire blocking in accordance with 2012, 2015, 2018, and 2021 IRC Section R302.11.1 shall be installed along the perimeter of the unprotected portion to separate the unprotected portion from the remainder of the floor assembly.
- (b) Insulation may be required for energy code compliance purposes. Check with the local building official for specific jurisdictional requirements.

(Continued next page)



(FP-01 Continued)

- (c) In accordance with 2012, 2015, 2018, and 2021 IRC Section P2904, partial residential sprinkler systems are permitted to be installed only when the entire dwelling unit is not required to be equipped with a residential sprinkler system. Check with the local building official for specific jurisdictional requirements.
- (d) Penetrations or openings for ducts, vents, electrical outlets, lighting, devices, luminaires, wires, speakers, drainage, piping and similar openings or penetrations shall be permitted.

REPRESENTING THE ENGINEERED WOOD INDUSTRY

7011 South 19th Street • Tacoma, Washington 98466-5333 • Phone: (253) 565-6600 • Fax: (253) 565-7265 • www.apawood.org



Fire Protection of Floors (FP-02) for Compliance with 2012 IRC Section R501.3 and 2015/2018/2021 IRC Section R302.13

Fire Protection: 1/2-inch Gypsum Board Attached Directly to Web

The following fire resistance design is an alternative to the 2-by-10 dimension lumber prescribed in 2012 IRC Section R501.3 and 2015/2018/2021 IRC Section R302.13 Exception 4, with demonstrated equivalent fire performance

Min. 9-1/2 inches (241 mm) Deep: BCI 50(S), 60(S), 65(S), 90(S), and 90e; All AJS Joists

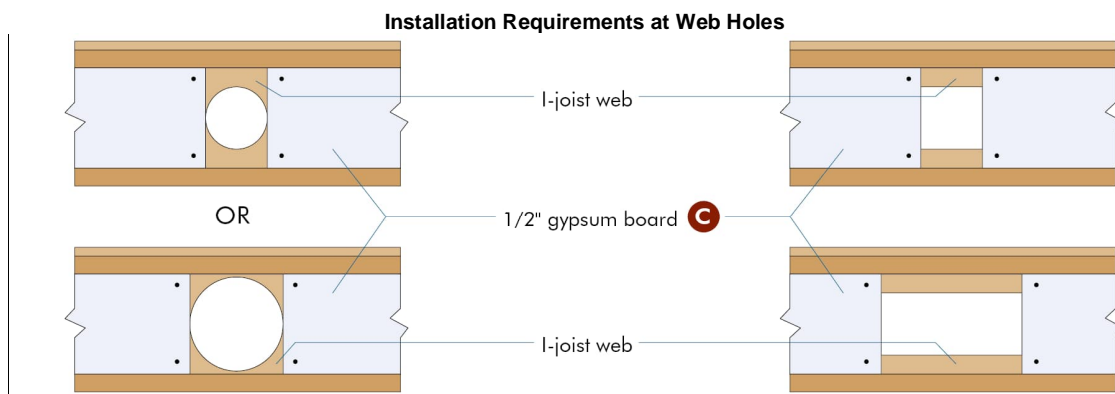
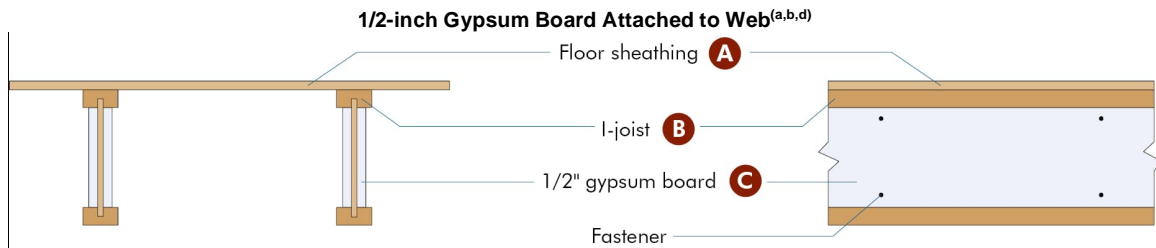

Crawl Space Exception^(b)

In accordance with Exception 2 of the 2012 IRC Section R501.3 and 2015/2018/2021 IRC Section R302.13, floor assemblies located directly over a crawl space not intended for storage or fuel-fired appliances do not require 1/2-inch gypsum board attached to web.

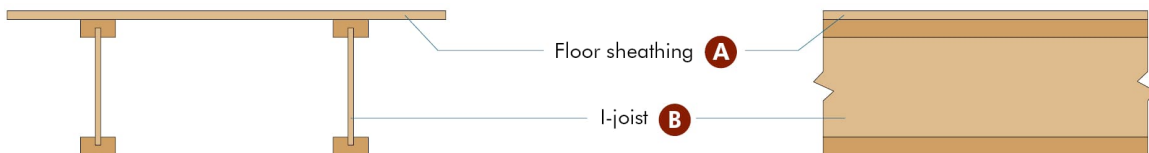

Automatic Sprinkler Exception^(c)

In accordance with Exception 1 of the 2012 IRC Section R501.3 and 2015/2018/2021 IRC Section R302.13, floor assemblies located directly over a space protected by an automatic sprinkler system do not require 1/2-inch gypsum board attached to web.

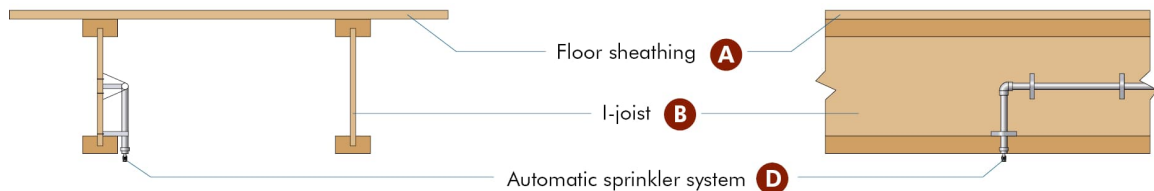

- (A) Floor sheathing: Materials and installation in accordance with 2012, 2015, 2018, and 2021 IRC Section R503.
- (B) I-joist: Installation in accordance with Section 4 of this report. Maximum 24 inches on center spacing. Minimum flange size of 1-1/2 inches thick x 2 inches wide. Minimum web thickness of 3/8 inch. Adhesives used shall be as described in the quality manual approved by APA. At hole location, fasteners shall be installed 1 inch from the edge of the gypsum board.

(Continued next page)

REPRESENTING THE ENGINEERED WOOD INDUSTRY



(FP-02 Continued)

- (C) 1/2-inch gypsum board: Materials (entire length of I-joint) in accordance with 2012, 2015, 2018, and 2021 IRC Section R702.3.1 (not required to be finished with tape and joint compound). Fasteners: Minimum 1-inch screws (Type W or Type S) or nails installed 1 inch from edges and 16 inches on center, top and bottom. Fasteners may be staggered from top to bottom.
- (D) Automatic sprinkler system: System in accordance with Section P2904 of the 2012, 2015, 2018, and 2021 IRC, NFPA 13D, or other equivalent sprinkler systems.

Notes:

- (a) In accordance with Exception 3 of the 2012 IRC Section R501.3 and 2015/2018/2021 IRC Section R302.13, portions of floor assembly can be unprotected when complying with the following:
 - 1) The aggregate area of the unprotected portions shall not exceed 80 square feet.
 - 2) Fire blocking in accordance with 2012, 2015, 2018, and 2021 IRC Section R302.11.1 shall be installed along the perimeter of the unprotected portion to separate the unprotected portion from the remainder of the floor assembly.
- (b) Insulation may be required for energy code compliance purposes. Check with the local building official for specific jurisdictional requirements.
- (c) In accordance with 2012, 2015, 2018, and 2021 IRC Section P2904, partial residential sprinkler systems are permitted to be installed only when the entire dwelling unit is not required to be equipped with a residential sprinkler system. Check with the local building official for specific jurisdictional requirements.
- (d) Penetrations or openings for ducts, vents, electrical outlets, lighting, devices, luminaires, wires, speakers, drainage, piping and similar openings or penetrations shall be permitted.



Fire Protection of Floors (FP-03) for Compliance with 2012 IRC Section R501.3 and 2015/2018/2021 IRC Section R302.13

Fire Protection: 1/2-inch Gypsum Board Attached Directly to Sides of Flange

The following fire resistance design is an alternative to the 2-by-10 dimension lumber prescribed in 2012 IRC Section R501.3 and 2015/2018/2021 IRC Section R302.13 Exception 4, with demonstrated equivalent fire performance

Min. 9-1/2 inches (241 mm) Deep: All BCI Joists except for BCI 40(S), 400(S), 4000(S) Joists; All AJS Joists

1/2-inch Gypsum Board Attached to Sides of Flange^(a,b,d)

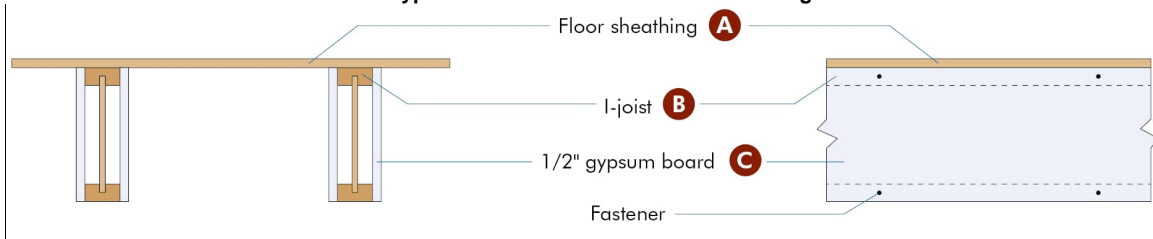

Installation Requirements at Web Holes

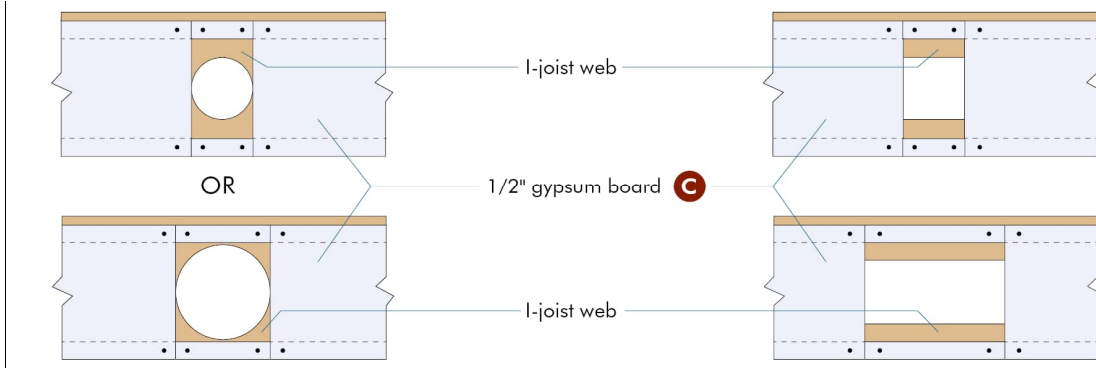

Crawl Space Exception^(b)

In accordance with Exception 2 of the 2012 IRC Section R501.3 and 2015/2018/2021 IRC Section R302.13, floor assemblies located directly over a crawl space not intended for storage or fuel-fired appliances do not require 1/2-inch gypsum board attached to sides of flange.

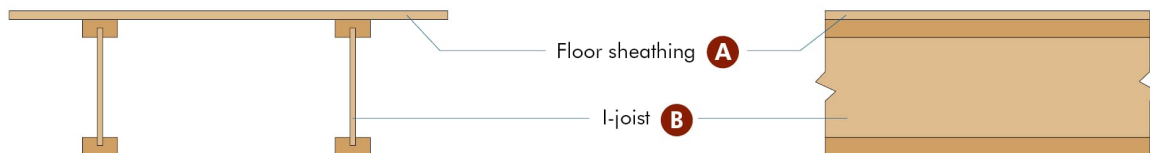

Automatic Sprinkler Exception^(c)

In accordance with Exception 1 of the 2012 IRC Section R501.3 and 2015/2018/2021 IRC Section R302.13, floor assemblies located directly over a space protected by an automatic sprinkler system do not require 1/2-inch gypsum board attached to sides of flange.

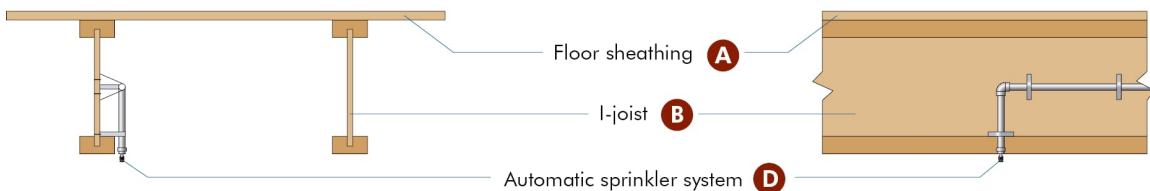

- (A) Floor sheathing: Materials and installation in accordance with 2012, 2015, 2018, and 2021 IRC Section R503.
- (B) I-joist: Installation in accordance with Section 4.0 of this report. Maximum 24 inches on center spacing. Minimum flange size of 1-1/8 inches thick x 1-3/4 inches wide. Minimum web thickness of 3/8 inch. Adhesives used shall be as described in the quality manual approved by APA. At hole location, fasteners shall be installed 1 inch from the edge of the gypsum board. Maximum fastener spacing shall be no more than 8 inches on gypsum board above and below the hole.

(Continued next page)

REPRESENTING THE ENGINEERED WOOD INDUSTRY



(FP-03 Continued)

- (C) 1/2-inch gypsum board: Materials (entire length of I-joint) in accordance with 2012, 2015, 2018, and 2021 IRC Section R702.3.1 (not required to be finished with tape and joint compound). Fasteners: Minimum 1-inch screws (Type W or Type S) or nails installed 1/2 inch from edges and 16 inches on center, top and bottom. Fasteners may be staggered from top to bottom.
- (D) Automatic sprinkler system: System in accordance with Section P2904 of the 2012, 2015, 2018, and 2021 IRC, NFPA 13D, or other equivalent sprinkler systems.

Notes:

- (a) In accordance with Exception 3 of the 2012 IRC Section R501.3 and 2015/2018/2021 IRC Section R302.13, portions of floor assembly can be unprotected when complying with the following:
 - 1) The aggregate area of the unprotected portions shall not exceed 80 square feet.
 - 2) Fire blocking in accordance with 2012, 2015, 2018, and 2021 IRC Section R302.11.1 shall be installed along the perimeter of the unprotected portion to separate the unprotected portion from the remainder of the floor assembly.
- (b) Insulation may be required for energy code compliance purposes. Check with the local building official for specific jurisdictional requirements.
- (c) In accordance with 2012, 2015, 2018, and 2021 IRC Section P2904, partial residential sprinkler systems are permitted to be installed only when the entire dwelling unit is not required to be equipped with a residential sprinkler system. Check with the local building official for specific jurisdictional requirements.
- (d) Penetrations or openings for ducts, vents, electrical outlets, lighting, devices, luminaires, wires, speakers, drainage, piping and similar openings or penetrations shall be permitted.



Fire Protection of Floors (FP-04) for Compliance with 2012 IRC Section R501.3 and 2015/2018/2021 IRC Section R302.13

Fire Protection: Mineral Wool Insulation

The following fire resistance design is an alternative to the 2-by-10 dimension lumber prescribed in 2012 IRC Section R501.3 and 2015/2018/2021 IRC Section R302.13 Exception 4, with demonstrated equivalent fire performance

Min. 9-1/2 inches (241 mm) Deep: All BCI Joists except for BCI 40(S), 400(S), 4000(S) Joists; All AJ5 Joists

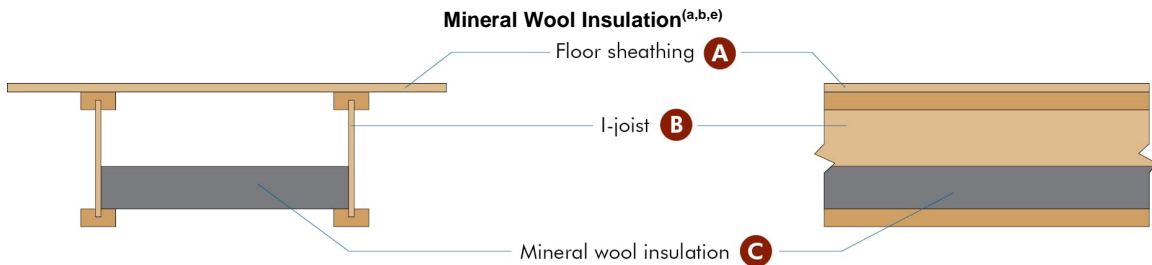

Crawl Space Exception^(c)

In accordance with Exception 2 of the 2012 IRC Section R501.3 and 2015/2018/2021 IRC Section R302.13, floor assemblies located directly over a crawl space not intended for storage or fuel-fired appliances do not require mineral wool insulation for fire protection.

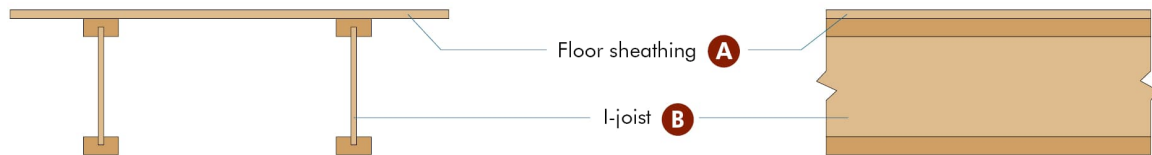

Automatic Sprinkler Exception^(d)

In accordance with Exception 1 of the 2012 IRC Section R501.3 and 2015/2018/2021 IRC Section R302.13, floor assemblies located directly over a space protected by an automatic sprinkler system do not require mineral wool insulation for fire protection.

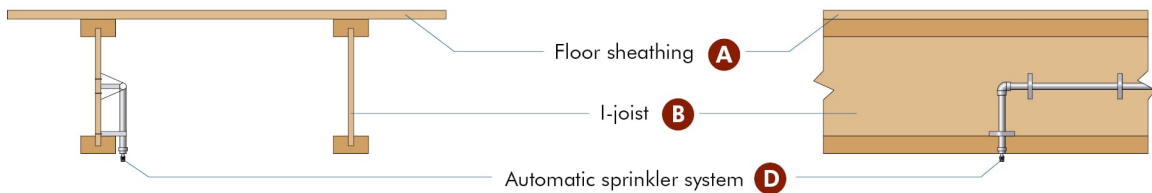

- (A) Floor sheathing: Materials and installation in accordance with 2012, 2015, 2018, and 2021 IRC Section R503.
- (B) I-joist: Installation in accordance with Section 4.0 of this report. Maximum 19.2 inches on center spacing for minimum flange size of 1-1/8 inches thick x 1-3/4 inches wide. Maximum 24 inches on center spacing for minimum flange size of 1-1/8 inch thick x 2 inches wide. Minimum web thickness of 3/8 inch. Adhesives used shall be as described in the quality manual approved by APA.
- (C) Mineral wool insulation: Minimum 2.0 lb/ft³ (nominal) and 2 inches thick mineral wool batt insulation installed as shown with insulation supports spaced no more than 19.2 inches apart and no more than 4 inches from ends of batts. Minimum 2.5 lb/ft³ (nominal) and 3 inches thick mineral wool batt insulation installed as shown with insulation supports spaced no more than 24 inches apart and no more than 6 inches from ends of batts. Use min. 15.25 inches, 18.5 inches, and 23 inches wide batts when I-joist spacing is 16 inches, 19.2 inches, and 24 inches on center, respectively.
- (D) Automatic sprinkler system: System in accordance with Section P2904 of the 2012, 2015, 2018, and 2021 IRC, NFPA 13D, or other equivalent sprinkler systems.

Notes:

- (a) In accordance with Exception 3 of 2012 IRC Section R501.3 and 2015/2018/2021 IRC Section R302.13, portions of floor assembly can be unprotected when complying with the following:
 - 1) The aggregate area of the unprotected portions shall not exceed 80 square feet.
 - 2) Fire blocking in accordance with 2012, 2015, 2018, and 2021 IRC Section R302.11.1 shall be installed along the perimeter of the unprotected portion to separate the unprotected portion from the remainder of the floor assembly.
- (b) Thicker insulation may be required for energy code compliance purposes. Check with the local building official for specific jurisdictional requirements.

(Continued next page)

REPRESENTING THE ENGINEERED WOOD INDUSTRY



(FP-04 Continued)

- (c) Insulation may be required for energy code compliance purposes. Check with the local building official for specific jurisdictional requirements.
- (d) In accordance with 2012, 2015, 2018, and 2021 IRC Section P2904, partial residential sprinkler systems are permitted to be installed only when the entire dwelling unit is not required to be equipped with a residential sprinkler system. Check with the local building official for specific jurisdictional requirements.
- (e) Penetrations or openings for ducts, vents, electrical outlets, lighting, devices, luminaires, wires, speakers, drainage, piping and similar openings or penetrations shall be permitted.

REPRESENTING THE ENGINEERED WOOD INDUSTRY

7011 South 19th Street • Tacoma, Washington 98466-5333 • Phone: (253) 565-6600 • Fax: (253) 565-7265 • www.apawood.org



Fire Protection of Floors (FP-06) for Compliance with 2012 IRC Section R501.3 and 2015/2018/2021 IRC Section R302.13

Fire Protection: 1/2-inch Gypsum Board Installed on Top of the Bottom Flange

The following fire resistance design is an alternative to the 2-by-10 dimension lumber prescribed in 2012 IRC Section R501.3 and 2015/2018/2021 IRC Section R302.13 Exception 4, with demonstrated equivalent fire performance

Min. 9-1/2 inches (241 mm) Deep: All BCI Joists except for BCI 40(S), 400(S), 4000(S), 45(S), 450(S), 4500(S) Joists; All AJS Joists

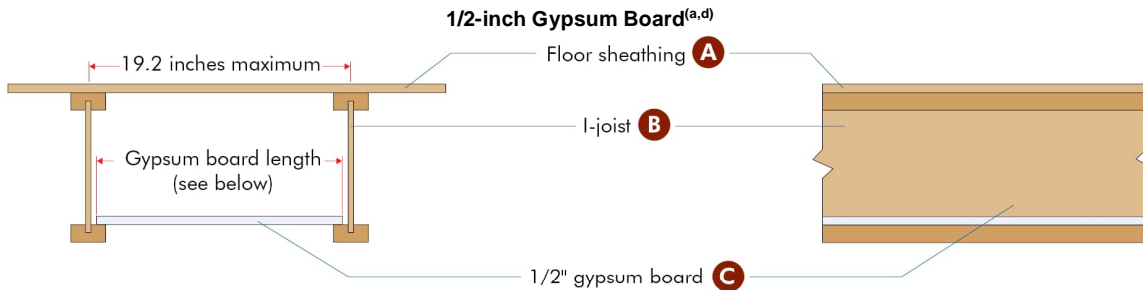

Joist spacing (in.)	Required length for gypsum boards (in.)
12	11-1/8 ± 1/8
16	15-1/8 ± 1/8
19.2	18-1/4 ± 1/8

Note:

Gypsum board lengths shown above provide at least 1/4" bearing on the top of the bottom flange in each I-joist as installed.

Crawl Space Exception^(b)

In accordance with Exception 2 of the 2012 IRC Section R501.3 and 2015/2018/2021 IRC Section R302.13, floor assemblies located directly over a crawl space not intended for storage or fuel-fired appliances do not require gypsum board for fire protection.

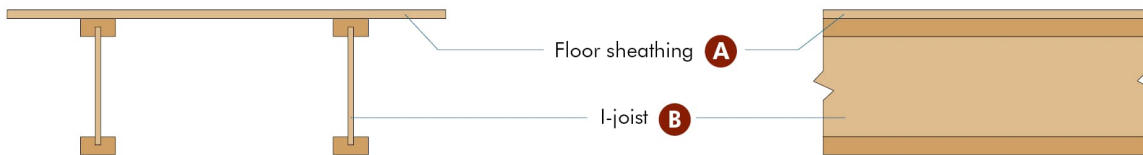

Automatic Sprinkler Exception^(c)

In accordance with Exception 1 of the 2012 IRC Section R501.3 and 2015/2018/2021 IRC Section R302.13, floor assemblies located directly over a space protected by an automatic sprinkler system do not require gypsum board for fire protection.

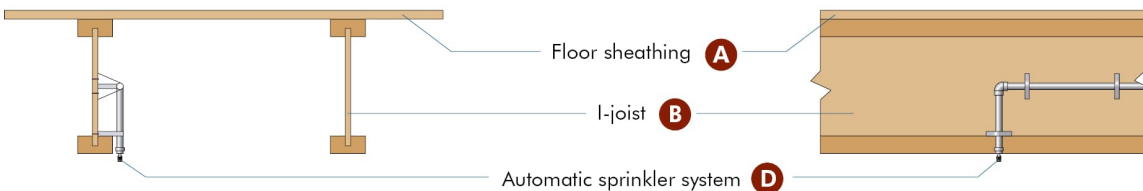

- (A) Floor sheathing: Materials and installation in accordance with 2012, 2015, 2018, and 2021 IRC Section R503.
- (B) I-joist: Installation in accordance with Section 4.0 of this report. Maximum 19.2 inches on center spacing. Minimum flange size of 1-1/8 inches thick x 2 inches wide. Minimum web thickness of 3/8 inch. Adhesives used shall be as described in the quality manual approved by APA.
- (C) 1-layer of 1/2-inch lightweight or normal weight (nominal 1.5 psf minimum) gypsum wall board meeting ASTM C1396 Section 5: Installed on the top of the bottom flange. Mechanical fastener or adhesive attachment to the top of the bottom flange is not required.
- (D) Automatic sprinkler system: System in accordance with Section P2904 of the 2012, 2015, 2018, and 2021 IRC, NFPA 13D, or other equivalent sprinkler systems.

(Continued next page)



(FP-06 Continued)

Notes:

- (a) In accordance with Exception 3 of 2012 IRC Section R501.3 and 2015/2018/2021 IRC Section R302.13, portions of floor assembly can be unprotected when complying with the following:
 - 1) The aggregate area of the unprotected portions shall not exceed 80 square feet.
 - 2) Fire blocking in accordance with 2012, 2015, 2018, and 2021 IRC Section R302.11.1 shall be installed along the perimeter of the unprotected portion to separate the unprotected portion from the remainder of the floor assembly.
- (b) Insulation may be required for energy code compliance purposes. Check with the local building official for specific jurisdictional requirements.
- (c) In accordance with 2012, 2015, 2018, and 2021 IRC Section P2904, partial residential sprinkler systems are permitted to be installed only when the entire dwelling unit is not required to be equipped with a residential sprinkler system. Check with the local building official for specific jurisdictional requirements.
- (d) Penetrations or openings for ducts, vents, electrical outlets, lighting, devices, luminaires, wires, speakers, drainage, piping and similar openings or penetrations shall be permitted.

REPRESENTING THE ENGINEERED WOOD INDUSTRY



Fire Protection of Floors (FP-07) for Compliance with 2012 IRC Section R501.3 and 2015/2018/2021 IRC Section R302.13

Fire Protection: 5/8-inch Gypsum Board Installed on Top of the Bottom Flange

The following fire resistance design is an alternative to the 2-by-10 dimension lumber prescribed in 2012 IRC Section R501.3 and 2015/2018/2021 IRC Section R302.13 Exception 4, with demonstrated equivalent fire performance

Min. 9-1/2 inches (241 mm) Deep: All BCI Joists except for BCI 40(S), 400(S), 4000(S), 45(S), 450(S), 4500(S) Joists; All AJS Joists

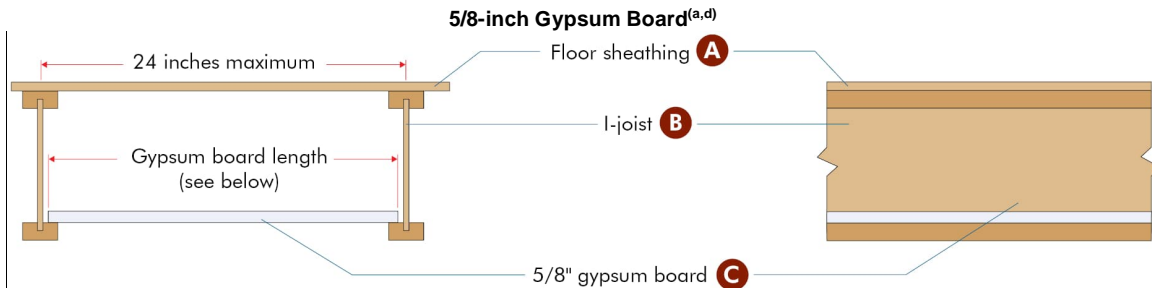

Joist spacing (in.)	Required length for gypsum boards (in.)
12	11-1/8 ± 1/8
16	15-1/8 ± 1/8
19.2	18-1/4 ± 1/8
24	23-1/8 ± 1/8

Note:

Gypsum board lengths shown above provide at least 1/4" bearing on the top of the bottom flange in each I-joist as installed.

Crawl Space Exception^(b)

In accordance with Exception 2 of the 2012 IRC Section R501.3 and 2015/2018/2021 IRC Section R302.13, floor assemblies located directly over a crawl space not intended for storage or fuel-fired appliances do not require gypsum board for fire protection.

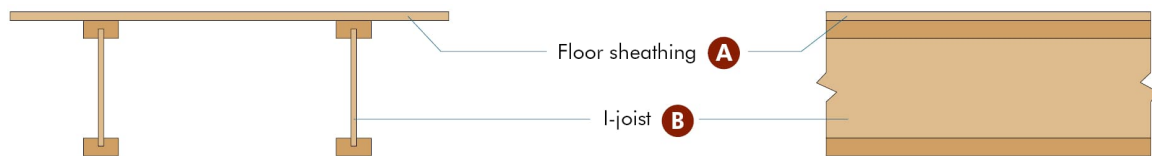

Automatic Sprinkler Exception^(c)

In accordance with Exception 1 of the 2012 IRC Section R501.3 and 2015/2018/2021 IRC Section R302.13, floor assemblies located directly over a space protected by an automatic sprinkler system do not require gypsum board for fire protection.

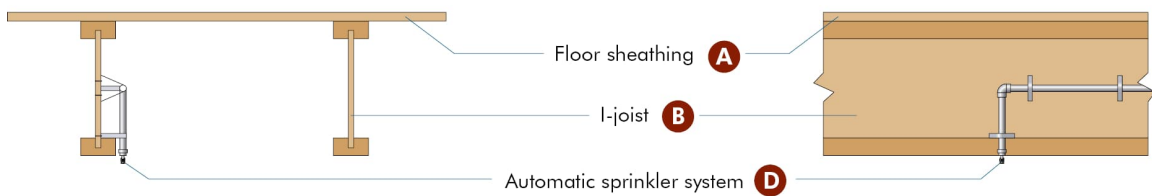

- (A) Floor sheathing: Materials and installation in accordance with 2012, 2015, 2018, and 2021 IRC Section R503.
- (B) I-joist: Installation in accordance with Section 4.0 of this report. Maximum 24 inches on center spacing. Minimum flange size of 1-1/8 inches thick x 2 inches wide. Minimum web thickness of 3/8 inch. Adhesives used shall be as described in the quality manual approved by APA.
- (C) 1-layer of 5/8-inch lightweight or normal weight (nominal 1.9 psf minimum) gypsum wall board meeting ASTM C1396 Section 5: Installed on the top of the bottom flange. Mechanical fastener or adhesive attachment to the top of the bottom flange is not required.
- (D) Automatic sprinkler system: System in accordance with Section P2904 of the 2012, 2015, 2018, and 2021 IRC, NFPA 13D, or other equivalent sprinkler systems.

(Continued next page)

REPRESENTING THE ENGINEERED WOOD INDUSTRY



(FP-07 Continued)

Notes:

- (a) In accordance with Exception 3 of 2012 IRC Section R501.3 and 2015/2018/2021 IRC Section R302.13, portions of floor assembly can be unprotected when complying with the following:
 - 1) The aggregate area of the unprotected portions shall not exceed 80 square feet.
 - 2) Fire blocking in accordance with 2012, 2015, 2018, and 2021 IRC Section R302.11.1 shall be installed along the perimeter of the unprotected portion to separate the unprotected portion from the remainder of the floor assembly.
- (b) Insulation may be required for energy code compliance purposes. Check with the local building official for specific jurisdictional requirements.
- (c) In accordance with 2012, 2015, 2018, and 2021 IRC Section P2904, partial residential sprinkler systems are permitted to be installed only when the entire dwelling unit is not required to be equipped with a residential sprinkler system. Check with the local building official for specific jurisdictional requirements.
- (d) Penetrations or openings for ducts, vents, electrical outlets, lighting, devices, luminaires, wires, speakers, drainage, piping and similar openings or penetrations shall be permitted.

REPRESENTING THE ENGINEERED WOOD INDUSTRY



Fire Protection of Floors (FP-08) for Compliance with 2012 IRC Section R501.3 and 2015/2018/2021 IRC Section R302.13

Fire Protection: Factory-Applied FireBreak HITS® Ceramic Fiber Board and Intumescent Paper

The following fire resistance design is an alternative to the 2-by-10 dimension lumber prescribed in 2012 IRC Section R501.3 and 2015/2018/2021 IRC Section R302.13 Exception 4, with demonstrated equivalent fire performance

Min. 9-1/2 inches (241 mm) Deep: BCI 60(S), 65(S), 90(S), and 90e Joists; All AJS Joists

Factory-Applied FireBreak HITS® Ceramic Fiber Board and Intumescent Paper^(a,b)

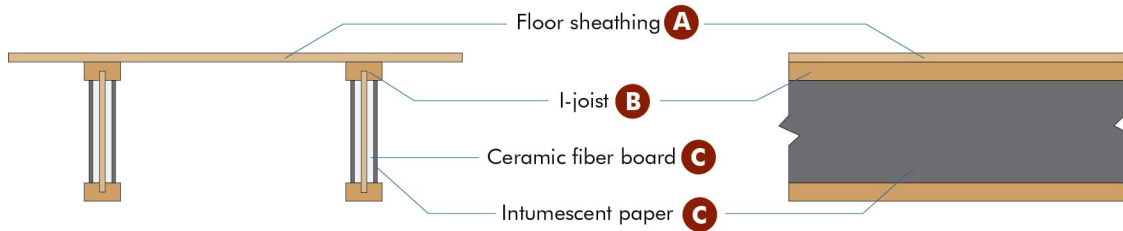

Crawl Space Exception^(c)

In accordance with Exception 2 of the 2012 IRC Section R501.3 and 2015/2018/2021 IRC Section R302.13, floor assemblies located directly over a crawl space not intended for storage or fuel-fired appliances do not require mineral wool insulation for fire protection.

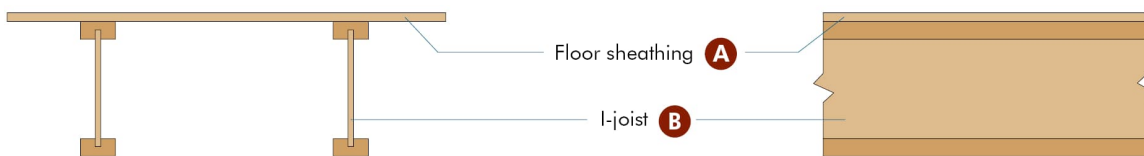

Automatic Sprinkler Exception^(d)

In accordance with Exception 1 of the 2012 IRC Section R501.3 and 2015/2018/2021 IRC Section R302.13, floor assemblies located directly over a space protected by an automatic sprinkler system do not require ceramic fiber board for fire protection.

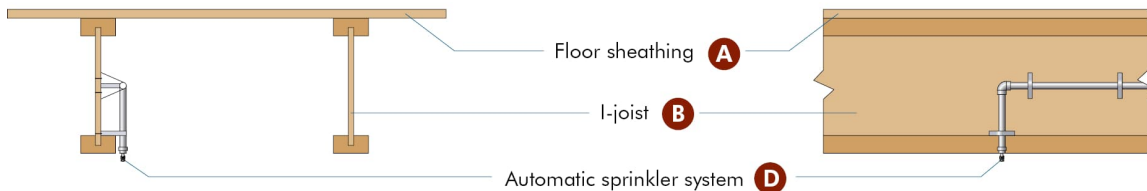

- (A) Floor sheathing: Materials and installation in accordance with 2012, 2015, 2018, and 2021 IRC Section R503.
- (B) I-joist: Installation in accordance with Section 4.0 of this report. Maximum 24 inches on center spacing. Minimum flange size of 1-1/2 inches thick x 2-5/16 inches wide. Minimum web thickness of 3/8 inch. I-joist adhesives used shall be as described in the quality manual approved by APA.
- (C) Factory-applied proprietary FireBreak HITS® Ceramic Fiber Board and Intumescent Paper: The factory-applied proprietary FireBreak HITS® ceramic fiber board and intumescent paper, as documented in the quality manual, covers the web.
- (D) Automatic sprinkler system: System in accordance with Section P2904 of the 2012, 2015, 2018, and 2021 IRC, NFPA 13D, or other equivalent sprinkler systems.

Notes:

- (a) In accordance with Exception 3 of 2012 IRC Section R501.3 and 2015/2018/2021 IRC Section R302.13, portions of floor assembly can be unprotected when complying with the following:
 - 1) The aggregate area of the unprotected portions shall not exceed 80 square feet.
 - 2) Fire blocking in accordance with 2012, 2015, 2018, and 2021 IRC Section R302.11.1 shall be installed along the perimeter of the unprotected portion to separate the unprotected portion from the remainder of the floor assembly.

(Continued next page)

REPRESENTING THE ENGINEERED WOOD INDUSTRY



(FP-08 Continued)

- (b) Insulation may be required for energy code compliance purposes. Check with the local building official for specific jurisdictional requirements.
- (c) In accordance with 2012, 2015, 2018, and 2021 IRC Section P2904, partial residential sprinkler systems are permitted to be installed only when the entire dwelling unit is not required to be equipped with a residential sprinkler system. Check with the local building official for specific jurisdictional requirements.
- (d) Penetrations or openings for ducts, vents, electrical outlets, lighting, devices, luminaires, wires, speakers, drainage, piping and similar openings or penetrations shall be permitted.

REPRESENTING THE ENGINEERED WOOD INDUSTRY

7011 South 19th Street • Tacoma, Washington 98466-5333 • Phone: (253) 565-6600 • Fax: (253) 565-7265 • www.apawood.org



Fire Protection of Floors (FP-09) for Compliance with 2012 IRC Section R501.3 and 2015/2018/2021 IRC Section R302.13

Fire Protection: Rockwool SAFE'n'SOUND® Mineral Wool Insulation

The following fire resistance design is an alternative to the 2-by-10 dimension lumber prescribed in 2012 IRC Section R501.3 and 2015/2018/2021 IRC Section R302.13 Exception 4, with demonstrated equivalent fire performance

Min. 9-1/2 inches (241 mm) Deep: All BCI Joists except for BCI 40(S), 400(S), 4000(S), 45(S), 450(S), 4500(S) Joists; All AJS Joists

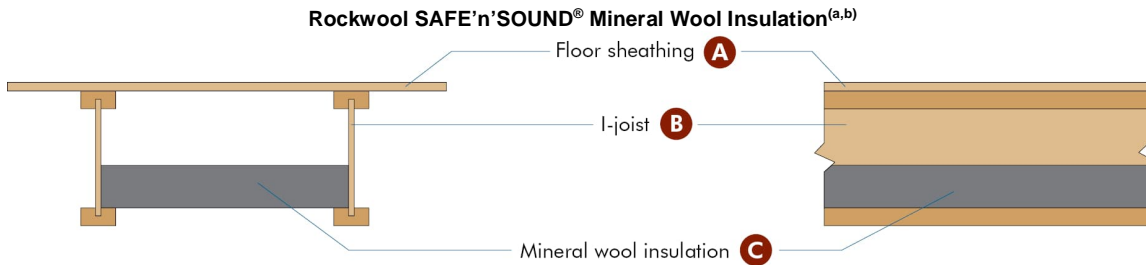

Crawl Space Exception^(c)

In accordance with Exception 2 of the 2012 IRC Section R501.3 and 2015/2018/2021 IRC Section R302.13, floor assemblies located directly over a crawl space not intended for storage or fuel-fired appliances do not require mineral wool insulation for fire protection.

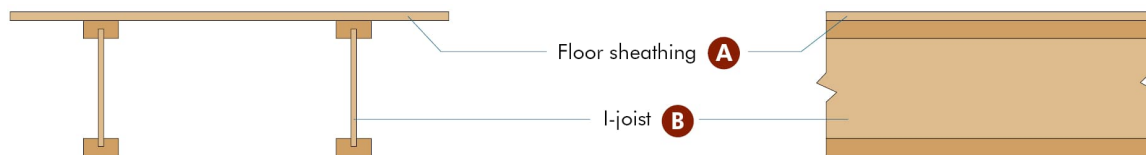

Automatic Sprinkler Exception^(d)

In accordance with Exception 1 of the 2012 IRC Section R501.3 and 2015/2018/2021 IRC Section R302.13, floor assemblies located directly over a space protected by an automatic sprinkler system do not require mineral wool insulation for fire protection.

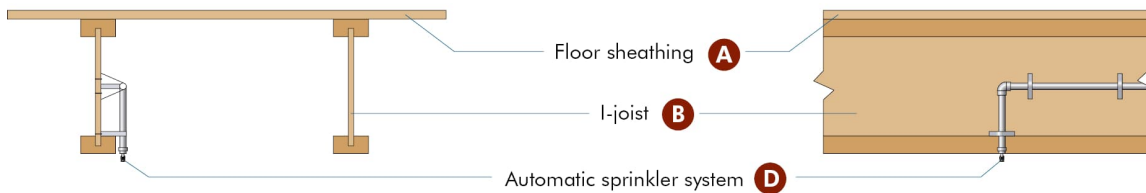

- (A) Floor sheathing: Materials and installation in accordance with 2012, 2015, 2018, and 2021 IRC Section R503.
- (B) I-joist: Installation in accordance with Section 4.0 of this report. Maximum 24 inches on center spacing. Minimum flange size of 1-1/8 inches thick x 2 inches wide. Minimum web thickness of 3/8 inch. Adhesives used shall be as described in the quality manual approved by APA.
- (C) Mineral wool insulation: Rockwool SAFE'n'SOUND® minimum 2.5 lb/ft³ (nominal) and 3 inches thick mineral wool batt insulation made of rock or furnace slag (ASTM C665 Type 1 compliant) installed as shown with insulation stay wire supports, spaced no more than 24 inches apart and no more than 4 inches from ends of batts. Use min. 15.25 inches, 18.5 inches, and 23 inches wide batts when I-joist spacing is 16 inches, 19.2 inches, and 24 inches on center, respectively.
- (D) Automatic sprinkler system: System in accordance with Section P2904 of the 2012, 2015, 2018, and 2021 IRC, NFPA 13D, or other equivalent sprinkler systems.

Notes:

- (a) In accordance with Exception 3 of 2012 IRC Section R501.3 and 2015/2018/2021 IRC Section R302.13, portions of floor assembly can be unprotected when complying with the following:
 - 1) The aggregate area of the unprotected portions shall not exceed 80 square feet.
 - 2) Fire blocking in accordance with 2012, 2015, 2018, and 2021 IRC Section R302.11.1 shall be installed along the perimeter of the unprotected portion to separate the unprotected portion from the remainder of the floor assembly.
- (b) Thicker insulation may be required for energy code compliance purposes. Check with the local building official for specific jurisdictional requirements.

(Continued next page)

REPRESENTING THE ENGINEERED WOOD INDUSTRY



(FP-09 Continued)

- (c) Insulation may be required for energy code compliance purposes. Check with the local building official for specific jurisdictional requirements.
- (d) In accordance with 2012, 2015, 2018, and 2021 IRC Section P2904, partial residential sprinkler systems are permitted to be installed only when the entire dwelling unit is not required to be equipped with a residential sprinkler system. Check with the local building official for specific jurisdictional requirements.
- (e) Penetrations or openings for ducts, vents, electrical outlets, lighting, devices, luminaires, wires, speakers, drainage, piping and similar openings or penetrations shall be permitted.

REPRESENTING THE ENGINEERED WOOD INDUSTRY

7011 South 19th Street • Tacoma, Washington 98466-5333 • Phone: (253) 565-6600 • Fax: (253) 565-7265 • www.apawood.org



Fire Protection of Floors (FP-10) for Compliance with 2012 IRC Section R501.3 and 2015/2018/2021 IRC Section R302.13

Fire Protection: FMJ - Factory-Applied Thermax™ Sheathing Board

The following fire resistance design is an alternative to the 2-by-10 dimension lumber prescribed in 2012 IRC Section R501.3 and 2015/2018/2021 IRC Section R302.13 Exception 4, with demonstrated equivalent fire performance

Min. 9-1/2 inches (241 mm) Deep: BCI 60(S), 65(S), 90(S), and 90e Joists; All AJS Joists

FMJ - Factory-Applied Thermax™ Sheathing Board (a,b)

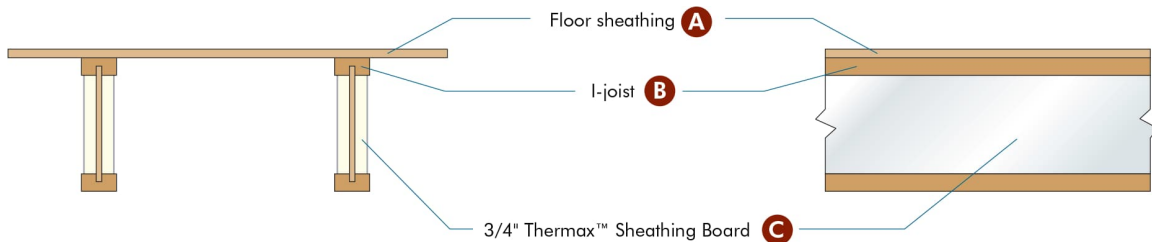

Crawl Space Exception(c)

In accordance with Exception 2 of the 2012 IRC Section R501.3 and 2015/2018/2021 IRC Section R302.13, floor assemblies located directly over a crawl space not intended for storage or fuel-fired appliances do not require additional fire protection.

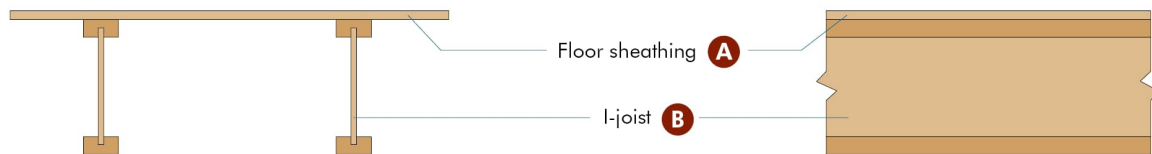

Automatic Sprinkler Exception(d)

In accordance with Exception 1 of the 2012 IRC Section R501.3 and 2015/2018/2021 IRC Section R302.13, floor assemblies located directly over a space protected by an automatic sprinkler system do not require additional fire protection.

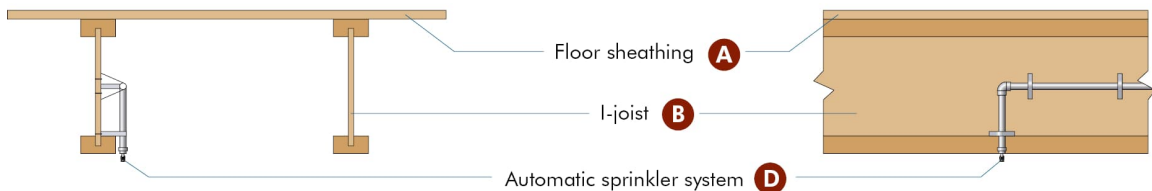

- (A) Floor sheathing: Materials and installation in accordance with 2012, 2015, 2018, and 2021 IRC Section R503.
- (B) I-joist: Installation in accordance with Section 4.0 of this report. Maximum 24 inches on center spacing. Minimum flange size of 1-1/2 inches thick x 2-5/16 inches wide. Minimum web thickness of 3/8 inch. I-joist adhesives used shall be as described in the quality manual approved by APA.
- (C) FMJ Factory-applied Thermax™ Sheathing Board: One layer of 3/4-inch thick Thermax™ Sheathing board conforming to ICC-ES ESR-1659 is adhered to each side of the I-joist web to tight fit within inside faces of the flanges. Adjacent Thermax™ Sheathing boards shall be tight fit in accordance with the in-plant manufacturing standard.
- (D) Automatic sprinkler system: System in accordance with Section P2904 of the 2012, 2015, 2018, and 2021 IRC, NFPA 13D, or other equivalent sprinkler systems.

Notes:

- (a) In accordance with Exception 3 of 2012 IRC Section R501.3 and 2015/2018/2021 IRC Section R302.13, portions of floor assembly can be unprotected when complying with the following:
 - 1) The aggregate area of the unprotected portions shall not exceed 80 square feet.
 - 2) Fire blocking in accordance with 2012, 2015, 2018, and 2021 IRC Section R302.11.1 shall be installed along the perimeter of the unprotected portion to separate the unprotected portion from the remainder of the floor assembly.
- (b) Insulation may be required for energy code compliance purposes. Check with the local building official for specific jurisdictional requirements.
- (c) In accordance with 2012, 2015, 2018, and 2021 IRC Section P2904, partial residential sprinkler systems are permitted to be installed only when the entire dwelling unit is not required to be equipped with a residential sprinkler system. Check with the local building official for specific jurisdictional requirements.
- (d) Penetrations or openings for ducts, vents, electrical outlets, lighting, devices, luminaires, wires, speakers, drainage, piping and similar openings or penetrations shall be permitted.

REPRESENTING THE ENGINEERED WOOD INDUSTRY



Fire Protection of Floors (FP-11) for Compliance with 2012 IRC Section R501.3 and 2015, 2018 and 2021 IRC Section R302.13

Fire Protection: 7/16 or Thicker Wood Structural Panel for Web Protection

The following fire resistance design is an alternative to the 2-by-10 dimension lumber prescribed in 2012 IRC Section R501.3 and 2015/2018/2021 IRC Section R302.13 Exception 4, with demonstrated equivalent fire performance

Min. 9-1/2 inches (241 mm) Deep: BCI 65(S), 90(S), and 90e Joists; All AJS Joists

7/16 in. (11 mm) or Thicker Wood Structural Panel for Web Protection ^(a,b,d)

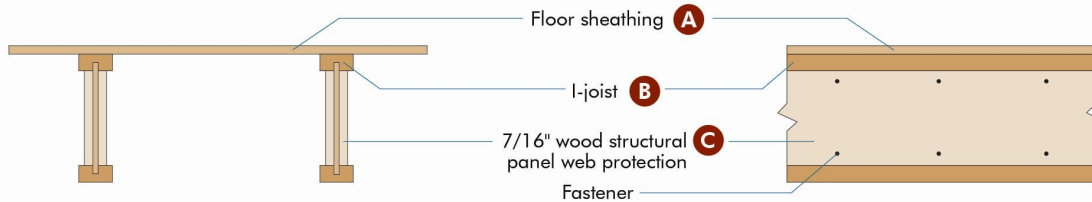

Installation Requirements at Web Holes

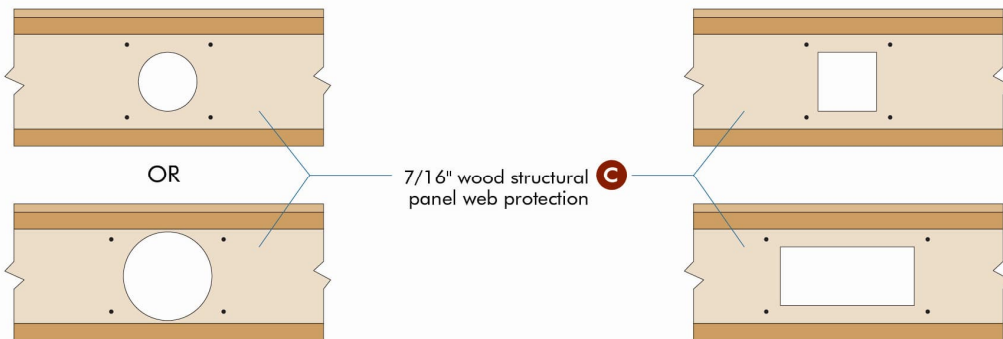

Crawl Space Exception^(b)

In accordance with Exception 2 of the 2012 IRC Section R501.3 and 2015/2018/2021 IRC Section R302.13, floor assemblies located directly over a crawl space not intended for storage or fuel-fired appliances do not require wood structural panel fire protection.

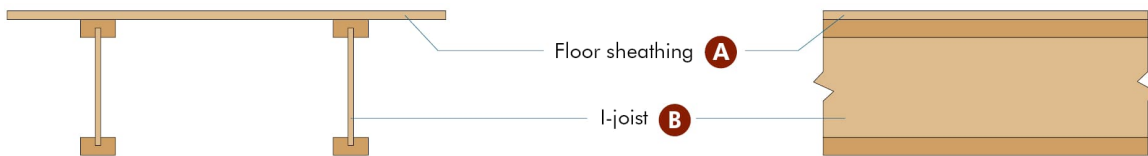

Automatic Sprinkler Exception^(c)

In accordance with Exception 1 of the 2012 IRC Section R501.3 and 2015/2018/2021 IRC Section R302.13, floor assemblies located directly over a space protected by an automatic sprinkler system do not require wood structural panel fire protection.

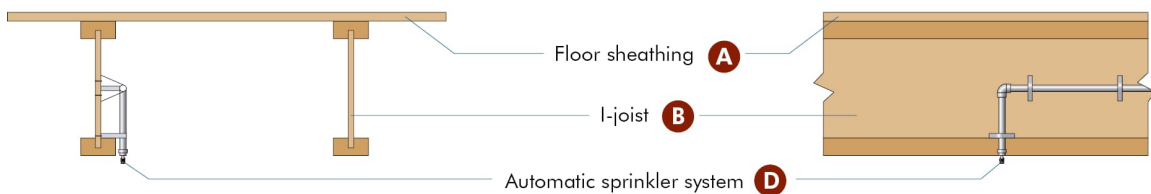

(Continued next page)

REPRESENTING THE ENGINEERED WOOD INDUSTRY



(FP-11 Continued)

- (A) Floor sheathing: Materials and installation in accordance with 2012, 2015, 2018, and 2021 IRC Section R503.
- (B) I-joist: Installation in accordance with Section 4.0 of this report. Maximum 24 inches (610 mm) on center spacing. Minimum flange size of 1-1/2 inches (38 mm) thick x 2-1/2 inches (63 mm) wide. Minimum web thickness of 3/8 inch (9.5 mm). Adhesives used shall be as described in the quality manual approved by APA. At each hole location, the 7/16 in. (11 mm) or thicker wood structural panels (WSP) shall be cut with the web hole on both sides of the I-joist to allow the passage of a wire, pipe, or duct, in accordance with the web hole requirements permitted in the I-joist product report.
- (C) Wood structural panel for web protection: Min. 7/16 Performance Category in compliance with DOC PS 1 or PS 2. The WSP shall continuously cover the entire length of the I-joist web on both sides. The panel-to-panel joints shall be tight with a joint gap of 1/16 inch (1.6 mm) or less and not required to be finished with tape or joint compound. Fasteners: Each WSP shall be fastened with 2 rows of 1/2 inch x 1 inch (12.7 mm x 25.4 mm) construction staples at 9 inches (229 mm) on center and 1 inch (25.4 mm) from the flange edge. Fasteners may be staggered from top to bottom. At hole location, fasteners shall be installed 1 inch (25.4 mm) from the edge of the hole, top and bottom.
- (D) Automatic sprinkler system: System in accordance with Section P2904 of the 2012, 2015, 2018 and 2021 IRC, NFPA 13D, or other equivalent sprinkler systems.

Notes:

- (a) In accordance with Exception 3 of 2012 IRC Section R501.3 and 2015/2018/2021 IRC Section R302.13, portions of floor assembly can be unprotected when complying with the following:
 - 1) The aggregate area of the unprotected portions shall not exceed 80 square feet (7.4 m²).
 - 2) Fire blocking in accordance with 2012, 2015, 2018, and 2021 IRC Section R302.11.1 shall be installed along the perimeter of the unprotected portion to separate the unprotected portion from the remainder of the floor assembly.
- (b) Insulation may be required for energy code compliance purposes. Check with the local building official for specific jurisdictional requirements.
- (c) In accordance with 2012, 2015, 2018, and 2021 IRC Section P2904, partial residential sprinkler systems are permitted to be installed only when the entire dwelling unit is not required to be equipped with a residential sprinkler system. Check with the local building official for specific jurisdictional requirements.
- (d) Penetrations or openings for ducts, vents, electrical outlets, lighting, devices, luminaires, wires, speakers, drainage, piping and similar openings or penetrations shall be permitted.



Fire Protection of Floors (FP-12) for Compliance with 2012 IRC Section R501.3 and 2015/2018/2021 IRC Section R302.13

Fire Protection: Field-Applied Firelam Laminate

The following fire resistance design is an alternative to the 2-by-10 dimension lumber prescribed in 2012 IRC Section R501.3 and 2015/2018/2021 IRC Section R302.13 Exception 4, with demonstrated equivalent fire performance

Min. 9-1/2 inches (241 mm) Deep: All BCI Joists Except for 40(S), 400(S), 4000(S), 45(S), 450(S), 4500(S), 50(S), 500(S), 5000(S) Joists; All AJS Joists

Field-Applied Firelam Laminate^(a,b,d)

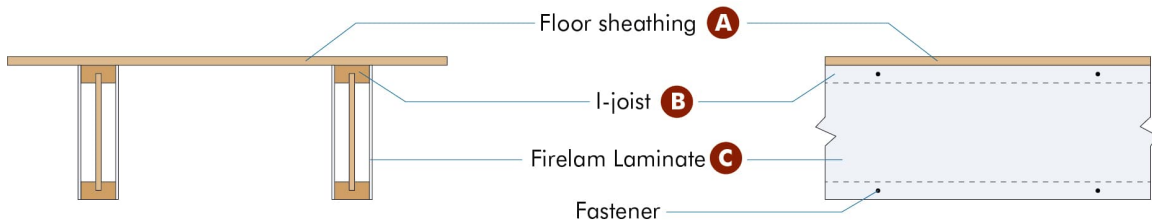

Crawl Space Exception^(b)

In accordance with Exception 2 of the 2012 IRC Section R501.3 and 2015/2018/2021 IRC Section R302.13, floor assemblies located directly over a crawl space not intended for storage or fuel-fired appliances do not require additional fire protection.

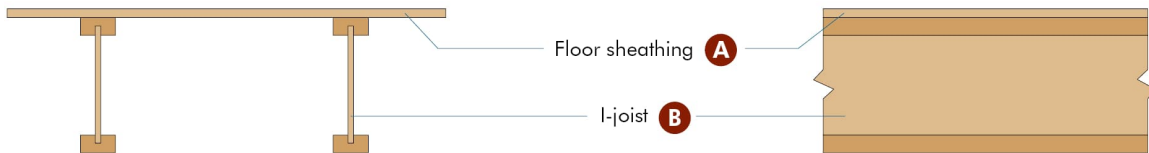

Automatic Sprinkler Exception^(c)

In accordance with Exception 1 of the 2012 IRC Section R501.3 and 2015/2018/2021 IRC Section R302.13, floor assemblies located directly over a space protected by an automatic sprinkler system do not require additional fire protection.

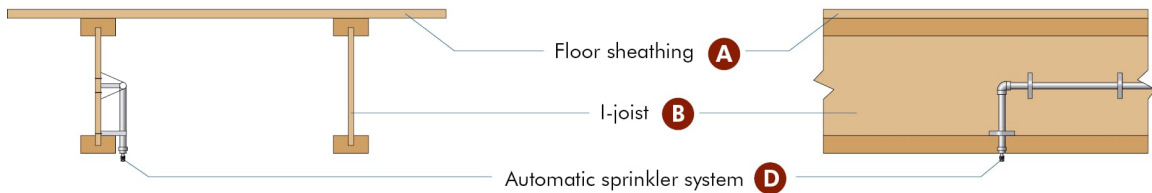

- (A) Floor sheathing: Materials and installation in accordance with 2012, 2015, 2018, and 2021 IRC Section R503.
- (B) I-joist: Installation in accordance with Section 4.0 of this report. Maximum 24 inches on center spacing. Minimum flange size of 1-1/8 inches thick x 2-5/16 inches wide. Minimum web thickness of 3/8 inch. I-joist adhesives used shall be as described in the quality manual approved by APA.
- (C) Field-applied proprietary Firelam Laminate: The field-applied proprietary Firelam Laminate conforming to ICC-ES ESL-1562 shall be attached to the upper and lower flanges for the full depth of the joist using 1/2-inch by 9/16-inch or larger staples placed at the mid-depth of I-joist flanges and spaced 8 inches o.c. maximum. Where web holes are permitted by the I-joist manufacturer, "X" slits of the web hole size shall be permitted to be cut into the Firelam Laminate at the hole locations.
- (D) Automatic sprinkler system: System in accordance with Section P2904 of the 2012, 2015, 2018, and 2021 IRC, NFPA 13D, or other equivalent sprinkler systems.

Notes:

- (a) In accordance with Exception 3 of 2012 IRC Section R501.3 and 2015/2018/2021 IRC Section R302.13, portions of floor assembly can be unprotected when complying with the following:
 - 1) The aggregate area of the unprotected portions shall not exceed 80 square feet.
 - 2) Fire blocking in accordance with 2012, 2015, 2018, and 2021 IRC Section R302.11.1 shall be installed along the perimeter of the unprotected portion to separate the unprotected portion from the remainder of the floor assembly.
- (b) Insulation may be required for energy code compliance purposes. Check with the local building official for specific jurisdictional requirements.

(Continued next page)

REPRESENTING THE ENGINEERED WOOD INDUSTRY



(FP-12 Continued)

- (c) In accordance with 2012, 2015, 2018, and 2021 IRC Section P2904, partial residential sprinkler systems are permitted to be installed only when the entire dwelling unit is not required to be equipped with a residential sprinkler system. Check with the local building official for specific jurisdictional requirements.
- (d) Penetrations or openings for ducts, vents, electrical outlets, lighting, devices, luminaires, wires, speakers, drainage, piping and similar openings or penetrations shall be permitted by slicing an "X" pattern in the laminate over the opening.

REPRESENTING THE ENGINEERED WOOD INDUSTRY

7011 South 19th Street • Tacoma, Washington 98466-5333 • Phone: (253) 565-6600 • Fax: (253) 565-7265 • www.apawood.org



Boise Cascade Assembly RB1

Fire Resistance Rated Rim Board Assembly

The following fire resistance design is listed in accordance with ASTM E119 and CAN/ULC S101

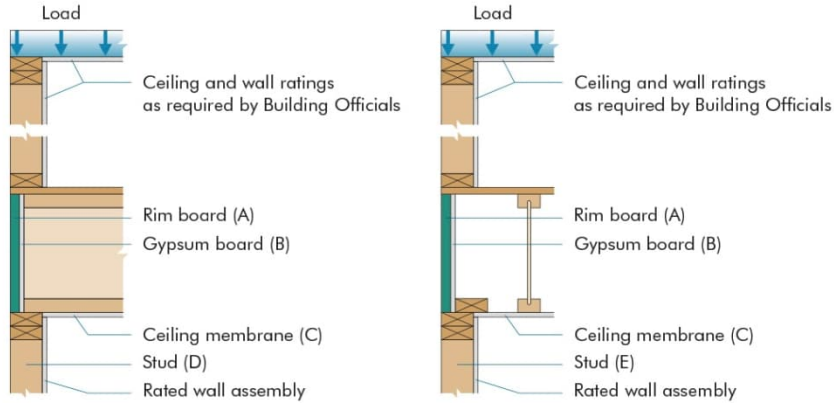

End Wall Configuration Base Assembly

Rim Board Thickness, in.	Rim Board Protection	Ceiling Membrane Req. for 1-hr	Ceiling Membrane Req. for 2-hr	Min. Stud Size	Min. Stud Size
A	B	C	C	D	E
1	Unprotected	1-hour Fire-rated Assembly	2-hour Fire-rated Assembly	2x4	2x4
	(1) 1/2" Type X	5/8" Type X	2-hour Fire-rated Assembly	2x4	2x4
	(1) 5/8" Type X	5/8" Regular	90-min Fire-rated Assembly	2x4	2x4
	(2) 1/2" Type X	No Ceiling Required	1-hour Fire-rated Assembly	2x6	2x4
1-1/8	(2) 5/8" Type X	No Ceiling Required	5/8" Type X	2x6	2x4
	Unprotected	1-hour Fire-rated Assembly	2-hour Fire-rated Assembly	2x4	2x4
	(1) 1/2" Type X	5/8" Type X	2-hour Fire-rated Assembly	2x4	2x4
	(1) 5/8" Type X	5/8" Regular	90-min Fire-rated Assembly	2x4	2x4
1-1/4	(2) 1/2" Type X	No Ceiling Required	1-hour Fire-rated Assembly	2x6	2x4
	(2) 5/8" Type X	No Ceiling Required	5/8" Type X	2x6	2x4
	Unprotected	1-hour Fire-rated Assembly	2-hour Fire-rated Assembly	2x4	2x4
	(1) 1/2" Type X	5/8" Type X	2-hour Fire-rated Assembly	2x4	2x4
1-1/2	(1) 5/8" Type X	1/2" Type X	90-min Fire-rated Assembly	2x6	2x4
	(2) 1/2" Type X	No Ceiling Required	1-hour Fire-rated Assembly	2x6	2x4
	(2) 5/8" Type X	No Ceiling Required	5/8" Type X	2x6	2x6
	Unprotected	1-hour Fire-rated Assembly	2-hour Fire-rated Assembly	2x4	2x4
1-3/4	(1) 1/2" Type X	5/8" Regular	90-min Fire-rated Assembly	2x6	2x4
	(1) 5/8" Type X	1/2" Type X	90-min Fire-rated Assembly	2x6	2x4
	(2) 1/2" Type X	No Ceiling Required	45-min Fire-rated Assembly	2x6	2x6
	(2) 5/8" Type X	No Ceiling Required	5/8" Type X	2x6	2x6

- Rim assembly for fire from inside of structure.
- Gypsum wallboard shown on the ceiling is to protect the Rim Board only. It does not necessarily cause the floor assembly to be rated.
- Attach 1-layer Type X (1/2 or 5/8-inch) gypsum wallboard to Rim Board with 1-1/2-inch Type W drywall screws spaced 12 inches o.c.
- Attach 2-layer Type X (1/2 or 5/8-inch) gypsum wallboard to Rim Board with 2-inch Type W drywall screws spaced 12 inches o.c.
- Provide min. 1-3/4-inch bearing for I-joist.
- Use only fire rated gypsum wallboard. Type C may be substituted for Type X.
- Rim Board and gypsum wallboard thickness are shown as minimums. Thicker Rim Board and gypsum wallboard may be substituted.
- When two layers of gypsum wallboard are used, I-joist end nails shall be 16d box (0.135 inch x 3-1/2 inches) nails.
- Rim board shall be sized for vertical and lateral load.
- Stud size may be reduced if the gypsum protection is discontinuous, provided that other requirements in the code are satisfied.

REPRESENTING THE ENGINEERED WOOD INDUSTRY



Boise Cascade Assembly RB2 Fire Resistance Rated Rim Board Assembly

The following fire resistance design is listed in accordance with ASTM E119 and CAN/ULC S101

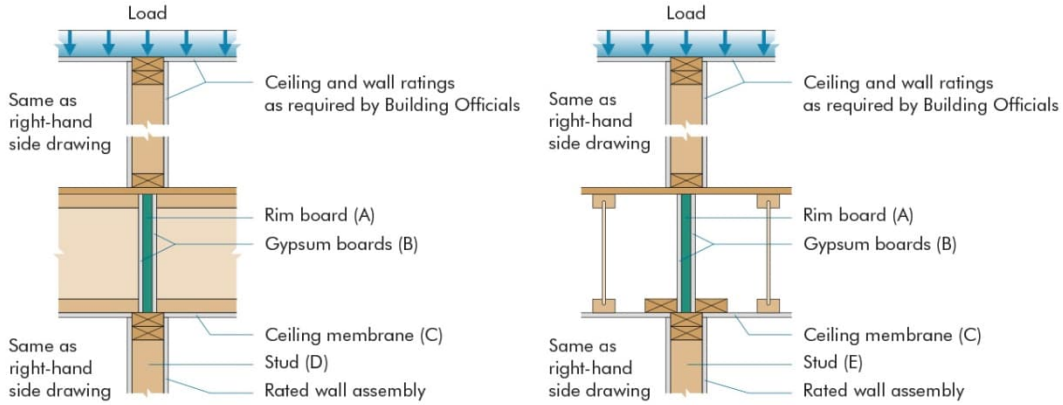

Single Wall Configuration Base Assembly

Rim Board Thickness, in.	Rim Board Protection	Ceiling Membrane Req. for 1-hr	Ceiling Membrane Req. for 2-hr	Min. Stud Size	Min. Stud Size
A	B	C	C	D	E
1	Unprotected	45-min Fire-rated Assembly	2-hour Fire-rated Assembly	2x6	2x4
	(1) 1/2" Type X	1/2" Type X	90-min Fire-rated Assembly	2x6	2x6
	(1) 5/8" Type X	1/2" Regular	90-min Fire-rated Assembly	2x8	2x6
	(2) 1/2" Type X	No Ceiling Required	5/8" Type X	2x8	2x6
	(2) 5/8" Type X	No Ceiling Required	1/2" Type X	2x8	2x6
1-1/8	Unprotected	5/8" Type X	2-hour Fire-rated Assembly	2x6	2x4
	(1) 1/2" Type X	1/2" Type X	90-min Fire-rated Assembly	2x8	2x6
	(1) 5/8" Type X	1/2" Regular	90-min Fire-rated Assembly	2x8	2x6
	(2) 1/2" Type X	No Ceiling Required	5/8" Regular	2x8	2x6
	(2) 5/8" Type X	No Ceiling Required	1/2" Type X	2x8	2x6
1-1/4	Unprotected	5/8" Type X	2-hour Fire-rated Assembly	2x6	2x4
	(1) 1/2" Type X	1/2" Regular	90-min Fire-rated Assembly	2x8	2x6
	(1) 5/8" Type X	1/2" Regular	90-min Fire-rated Assembly	2x8	2x6
	(2) 1/2" Type X	No Ceiling Required	1/2" Type X	2x8	2x6
	(2) 5/8" Type X	No Ceiling Required	1/2" Regular	2x8	2x6
1-1/2	Unprotected	5/8" Type X	2-hour Fire-rated Assembly	2x6	2x4
	(1) 1/2" Type X	1/2" Regular	90-min Fire-rated Assembly	2x8	2x6
	(1) 5/8" Type X	No Ceiling Required	1-hour Fire-rated Assembly	2x8	2x6
	(2) 1/2" Type X	No Ceiling Required	1/2" Type X	2x8	2x6
	(2) 5/8" Type X	No Ceiling Required	1/2" Regular	2x10	2x8
1-3/4	Unprotected	5/8" Regular	90-min Fire-rated Assembly	2x6	2x4
	(1) 1/2" Type X	1/2" Regular	90-min Fire-rated Assembly	2x8	2x6
	(1) 5/8" Type X	No Ceiling Required	1-hour Fire-rated Assembly	2x8	2x6
	(2) 1/2" Type X	No Ceiling Required	1/2" Regular	2x8	2x6
	(2) 5/8" Type X	No Ceiling Required	No Ceiling Required	2x10	2x8

- 1) Rim assembly for fire from either side of wall.
- 2) Gypsum wallboard shown on the ceiling is to protect the Rim Board only. It does not necessarily cause the floor assembly to be rated.
- 3) Attach 1-layer Type X (1/2 or 5/8-inch) gypsum wallboard to Rim Board with 1-1/2-inch Type W drywall screws spaced 12 inches o.c.
- 4) Attach 2-layer Type X (1/2 or 5/8-inch) gypsum wallboard to Rim Board with 2-inch Type W drywall screws spaced 12 inches o.c.
- 5) Provide min. 1-3/4-inch bearing for I-joist.
- 6) Use only fire rated gypsum wallboard. Type C may be substituted for Type X.
- 7) Rim Board and gypsum wallboard thickness are shown as minimums. Thicker Rim Board and gypsum wallboard may be substituted.
- 8) Toe nailing from the I-joist flange to the rim is permitted. When 2-layer (or more) gypsum wallboards are used, I-joist end nails shall be 16d box (0.135 inch x 3-1/2 inches) nails.
- 9) Rim board shall be sized for vertical and lateral load.
- 10) Stud size may be reduced if the gypsum protection is discontinuous, provided that other requirements in the code are satisfied.

REPRESENTING THE ENGINEERED WOOD INDUSTRY

Boise Cascade Assembly RB3 Fire Resistance Rated Rim Board Assembly

The following fire resistance design is listed in accordance with ASTM E119 and CAN/ULC S101

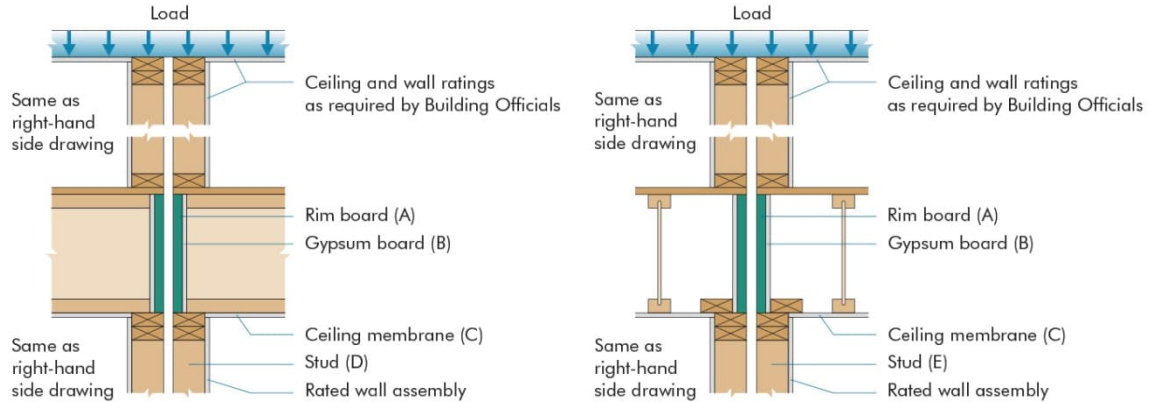

Double Wall Configuration with Load Transfer Base Assembly

Rim Board Thickness, in.	Rim Board Protection	Ceiling Membrane Req. for 1-hr	Ceiling Membrane Req. for 2-hr	Min. Stud Size	Min. Stud Size
A	B	C	C	D	E
1	Unprotected	1/2" Type X	90-min Fire-rated Assembly	2x4	2x4
	(1) 1/2" Type X	No Ceiling Required	1-hour Fire-rated Assembly	2x4	2x4
	(1) 5/8" Type X	No Ceiling Required	45-min Fire-rated Assembly	2x4	2x4
	(2) 1/2" Type X	No Ceiling Required	No Ceiling Required	2x6	2x4
	(2) 5/8" Type X	No Ceiling Required	No Ceiling Required	2x6	2x4
1-1/8	Unprotected	1/2" Type X	90 min Fire-rated Assembly	2x4	2x4
	(1) 1/2" Type X	No Ceiling Required	1-hour Fire-rated Assembly	2x4	2x4
	(1) 5/8" Type X	No Ceiling Required	5/8" Type X	2x4	2x4
	(2) 1/2" Type X	No Ceiling Required	No Ceiling Required	2x6	2x4
	(2) 5/8" Type X	No Ceiling Required	No Ceiling Required	2x6	2x4
1-1/4	Unprotected	1/2" Regular	90 min Fire-rated Assembly	2x4	2x4
	(1) 1/2" Type X	No Ceiling Required	45-min Fire-rated Assembly	2x4	2x4
	(1) 5/8" Type X	No Ceiling Required	5/8" Regular	2x6	2x4
	(2) 1/2" Type X	No Ceiling Required	No Ceiling Required	2x6	2x4
	(2) 5/8" Type X	No Ceiling Required	No Ceiling Required	2x6	2x4
1-1/2	Unprotected	No Ceiling Required	1-hour Fire-rated Assembly	2x4	2x4
	(1) 1/2" Type X	No Ceiling Required	5/8" Type X	2x6	2x4
	(1) 5/8" Type X	No Ceiling Required	1/2" Regular	2x6	2x4
	(2) 1/2" Type X	No Ceiling Required	No Ceiling Required	2x6	2x4
	(2) 5/8" Type X	No Ceiling Required	No Ceiling Required	2x6	2x6
1-3/4	Unprotected	No Ceiling Required	1-hour Fire-rated Assembly	2x4	2x4
	(1) 1/2" Type X	No Ceiling Required	1/2" Type X	2x6	2x4
	(1) 5/8" Type X	No Ceiling Required	No Ceiling Required	2x6	2x4
	(2) 1/2" Type X	No Ceiling Required	No Ceiling Required	2x6	2x6
	(2) 5/8" Type X	No Ceiling Required	No Ceiling Required	2x6	2x6

- 1) Rim assembly for fire from either side of wall. "With load transfer" assumes load transfers to the adjacent rim board if the fire exposed rim board fails.
- 2) Gypsum wallboard shown on the ceiling is to protect the Rim Board only. It does not necessarily cause the floor assembly to be rated.
- 3) Attach 1-layer Type X (1/2 or 5/8-inch) gypsum wallboard to Rim Board with 1-1/2-inch Type W drywall screws spaced 12 inches o.c.
- 4) Attach 2-layer Type X (1/2 or 5/8-inch) gypsum wallboard to Rim Board with 2-inch Type W drywall screws spaced 12 inches o.c.
- 5) Provide min. 1-3/4-inch bearing for I-joist.
- 6) Use only fire rated gypsum wallboard. Type C may be substituted for Type X.
- 7) Rim Board and gypsum wallboard thickness are shown as minimums. Thicker Rim Board and gypsum wallboard may be substituted.
- 8) Toe nailing from the I-joist flange to the rim is permitted. When 2-layer (or more) gypsum wallboards are used, I-joist end nails shall be 16d box (0.135 inch x 3-1/2 inches) nails.
- 9) Rim board shall be sized for vertical and lateral load.
- 10) Stud size may be reduced if the gypsum protection is discontinuous, provided that other requirements in the code are satisfied.



Boise Cascade Assembly RB4 Fire Resistance Rated Rim Board Assembly

The following fire resistance design is listed in accordance with ASTM E119 and CAN/ULC S101

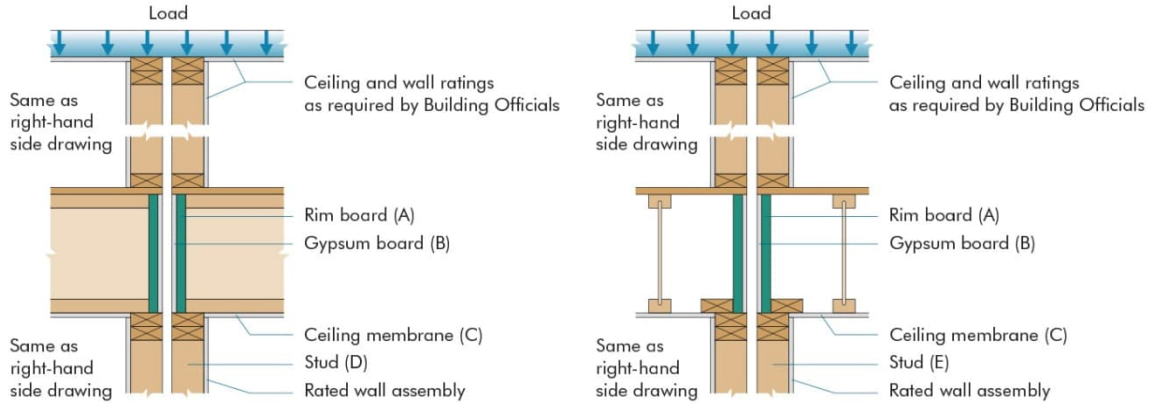

Double Wall Configuration with Load Transfer Base Assembly

Rim Board Thickness, in.	Rim Board Protection	Ceiling Membrane Req. for 1-hr	Ceiling Membrane Req. for 2-hr	Min. Stud Size	Min. Stud Size
A	B	C	C	D	E
1	Unprotected	1/2" Type X	90-min Fire-rated Assembly	2x4	2x4
	(1) 1/2" Type X	No Ceiling Required	1-hour Fire-rated Assembly	2x4	2x4
	(1) 5/8" Type X	No Ceiling Required	1-hour Fire-rated Assembly	2x4	2x4
	(2) 1/2" Type X	No Ceiling Required	1/2" Type X	2x6	2x4
1-1/8	Unprotected	1/2" Type X	90 min Fire-rated Assembly	2x4	2x4
	(1) 1/2" Type X	No Ceiling Required	1-hour Fire-rated Assembly	2x4	2x4
	(1) 5/8" Type X	No Ceiling Required	1-hour Fire-rated Assembly	2x4	2x4
	(2) 1/2" Type X	No Ceiling Required	1/2" Regular	2x6	2x4
1-1/4	Unprotected	1/2" Regular	90 min Fire-rated Assembly	2x4	2x4
	(1) 1/2" Type X	No Ceiling Required	1-hour Fire-rated Assembly	2x4	2x4
	(1) 5/8" Type X	No Ceiling Required	45-min Fire-rated Assembly	2x6	2x4
	(2) 1/2" Type X	No Ceiling Required	1/2" Regular	2x6	2x4
1-1/2	Unprotected	No Ceiling Required	1-hour Fire-rated Assembly	2x4	2x4
	(1) 1/2" Type X	No Ceiling Required	5/8" Type X	2x6	2x4
	(1) 5/8" Type X	No Ceiling Required	5/8" Regular	2x6	2x4
	(2) 1/2" Type X	No Ceiling Required	No Ceiling Required	2x6	2x4
1-3/4	Unprotected	No Ceiling Required	1-hour Fire-rated Assembly	2x4	2x4
	(1) 1/2" Type X	No Ceiling Required	1/2" Type X	2x6	2x4
	(1) 5/8" Type X	No Ceiling Required	1/2" Regular	2x6	2x4
	(2) 1/2" Type X	No Ceiling Required	No Ceiling Required	2x6	2x6
	(2) 5/8" Type X	No Ceiling Required	No Ceiling Required	2x6	2x6

- 1) Rim assembly for fire from either side of wall. "With load transfer" assumes load transfers to the adjacent rim board if the fire exposed rim board fails.
- 2) Gypsum wallboard shown on the ceiling is to protect the Rim Board only. It does not necessarily cause the floor assembly to be rated.
- 3) Attach 1-layer Type X (1/2 or 5/8-inch) gypsum wallboard to Rim Board with 1-1/2-inch Type W drywall screws spaced 12 inches o.c.
- 4) Attach 2-layer Type X (1/2 or 5/8-inch) gypsum wallboard to Rim Board with 2-inch Type W drywall screws spaced 12 inches o.c.
- 5) Provide min. 1-3/4-inch bearing for I-joist.
- 6) Use only fire rated gypsum wallboard. Type C may be substituted for Type X.
- 7) Rim Board and gypsum wallboard thickness are shown as minimums. Thicker Rim Board and gypsum wallboard may be substituted.
- 8) Toe nailing from the I-joist flange to the rim is permitted. When 2-layer (or more) gypsum wallboards are used, I-joist end nails shall be 16d box (0.135 inch x 3-1/2 inches) nails.
- 9) Rim board shall be sized for vertical and lateral load.
- 10) Stud size may be reduced if the gypsum protection is discontinuous, provided that other requirements in the code are satisfied.

REPRESENTING THE ENGINEERED WOOD INDUSTRY



Boise Cascade Assembly RB5 Fire Resistance Rated Rim Board Assembly

The following fire resistance design is listed in accordance with ASTM E119 and CAN/ULC S101

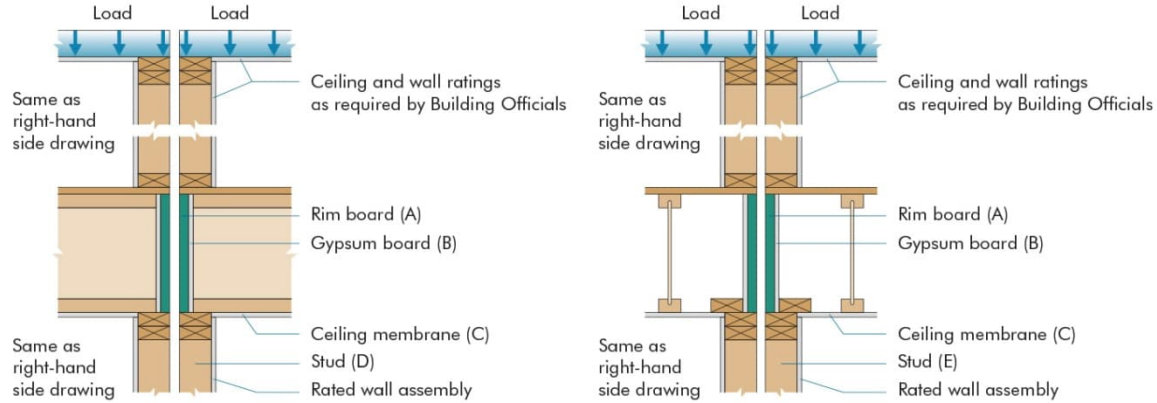

Double Wall Configuration with No Load Transfer Base Assembly

Rim Board Thickness, in.	Rim Board Protection	Ceiling Membrane Req. for 1-hr	Ceiling Membrane Req. for 2-hr	Min. Stud Size	Min. Stud Size
A	B	C	C	D	E
1	Unprotected	5/8" Type X	2-hour Fire-rated Assembly	2x4	2x4
	(1) 1/2" Type X	1/2" Type X	90-min Fire-rated Assembly	2x4	2x4
	(1) 5/8" Type X	1/2" Regular	90-min Fire-rated Assembly	2x4	2x4
	(2) 1/2" Type X	No Ceiling Required	5/8" Type X	2x6	2x4
	(2) 5/8" Type X	No Ceiling Required	1/2" Type X	2x6	2x4
1-1/8	Unprotected	5/8" Type X	2-hour Fire-rated Assembly	2x4	2x4
	(1) 1/2" Type X	1/2" Regular	90-min Fire-rated Assembly	2x4	2x4
	(1) 5/8" Type X	1/2" Regular	90-min Fire-rated Assembly	2x4	2x4
	(2) 1/2" Type X	No Ceiling Required	5/8" Type X	2x6	2x4
	(2) 5/8" Type X	No Ceiling Required	1/2" Type X	2x6	2x4
1-1/4	Unprotected	5/8" Type X	2-hour Fire-rated Assembly	2x4	2x4
	(1) 1/2" Type X	1/2" Regular	90-min Fire-rated Assembly	2x4	2x4
	(1) 5/8" Type X	1/2" Regular	90-min Fire-rated Assembly	2x6	2x4
	(2) 1/2" Type X	No Ceiling Required	5/8" Regular	2x6	2x4
	(2) 5/8" Type X	No Ceiling Required	1/2" Regular	2x6	2x4
1-1/2	Unprotected	1/2" Type X	90-min Fire-rated Assembly	2x4	2x4
	(1) 1/2" Type X	1/2" Regular	90-min Fire-rated Assembly	2x6	2x4
	(1) 5/8" Type X	No Ceiling Required	1-hour Fire-rated Assembly	2x6	2x4
	(2) 1/2" Type X	No Ceiling Required	1/2" Type X	2x6	2x4
	(2) 5/8" Type X	No Ceiling Required	1/2" Regular	2x6	2x6
1-3/4	Unprotected	1/2" Type X	90-min Fire-rated Assembly	2x4	2x4
	(1) 1/2" Type X	No Ceiling Required	1-hour Fire-rated Assembly	2x6	2x4
	(1) 5/8" Type X	No Ceiling Required	1-hour Fire-rated Assembly	2x6	2x4
	(2) 1/2" Type X	No Ceiling Required	1/2" Regular	2x6	2x6
	(2) 5/8" Type X	No Ceiling Required	No Ceiling Required	2x6	2x6

- 1) Rim assembly for fire from either side of wall. "With no load transfer" assumes no load transfers to the adjacent rim board if the fire exposed rim board fails.
- 2) Gypsum wallboard shown on the ceiling is to protect the Rim Board only. It does not necessarily cause the floor assembly to be rated.
- 3) Attach 1-layer Type X (1/2 or 5/8-inch) gypsum wallboard to Rim Board with 1-1/2-inch Type W drywall screws spaced 12 inches o.c.
- 4) Attach 2-layer Type X (1/2 or 5/8-inch) gypsum wallboard to Rim Board with 2-inch Type W drywall screws spaced 12 inches o.c.
- 5) Provide min. 1-3/4-inch bearing for I-joist.
- 6) Use only fire rated gypsum wallboard. Type C may be substituted for Type X.
- 7) Rim Board and gypsum wallboard thickness are shown as minimums. Thicker Rim Board and gypsum wallboard may be substituted.
- 8) Toe nailing from the I-joist flange to the rim is permitted. When 2-layer (or more) gypsum wallboards are used, I-joist end nails shall be 16d box (0.135 inch x 3-1/2 inches) nails.
- 9) Rim board shall be sized for vertical and lateral load.
- 10) Stud size may be reduced if the gypsum protection is discontinuous, provided that other requirements in the code are satisfied.

REPRESENTING THE ENGINEERED WOOD INDUSTRY



Boise Cascade Assembly RB6 Fire Resistance Rated Rim Board Assembly

The following fire resistance design is listed in accordance with ASTM E119 and CAN/ULC S101

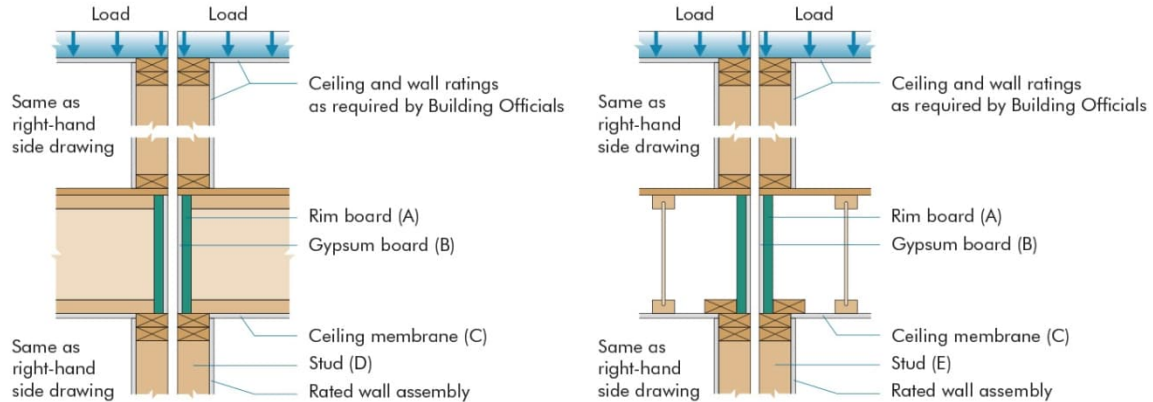

Double Wall Configuration with No Load Transfer Base Assembly

Rim Board Thickness, in.	Rim Board Protection	Ceiling Membrane Req. for 1-hr	Ceiling Membrane Req. for 2-hr	Min. Stud Size	Min. Stud Size
A	B	C	C	D	E
1	Unprotected	5/8" Type X	2-hour Fire-rated Assembly	2x4	2x4
	(1) 1/2" Type X	1/2" Regular	90-min Fire-rated Assembly	2x4	2x4
	(1) 5/8" Type X	1/2" Regular	90-min Fire-rated Assembly	2x4	2x4
	(2) 1/2" Type X	No Ceiling Required	5/8" Regular	2x6	2x4
1-1/8	Unprotected	5/8" Type X	2-hour Fire-rated Assembly	2x4	2x4
	(1) 1/2" Type X	1/2" Regular	90-min Fire-rated Assembly	2x4	2x4
	(1) 5/8" Type X	1/2" Regular	90-min Fire-rated Assembly	2x4	2x4
	(2) 1/2" Type X	No Ceiling Required	1/2" Type X	2x6	2x4
1-1/4	Unprotected	5/8" Type X	2-hour Fire-rated Assembly	2x4	2x4
	(1) 1/2" Type X	1/2" Regular	90-min Fire-rated Assembly	2x4	2x4
	(1) 5/8" Type X	No Ceiling Required	1-hour Fire-rated Assembly	2x6	2x4
	(2) 1/2" Type X	No Ceiling Required	1/2" Type X	2x6	2x4
1-1/2	Unprotected	5/8" Type X	2-hour Fire-rated Assembly	2x4	2x4
	(1) 1/2" Type X	1/2" Regular	90-min Fire-rated Assembly	2x6	2x4
	(1) 5/8" Type X	No Ceiling Required	1-hour Fire-rated Assembly	2x6	2x4
	(2) 1/2" Type X	No Ceiling Required	1/2" Regular	2x6	2x4
1-3/4	Unprotected	1/2" Type X	90-min Fire-rated Assembly	2x4	2x4
	(1) 1/2" Type X	No Ceiling Required	1-hour Fire-rated Assembly	2x6	2x4
	(1) 5/8" Type X	No Ceiling Required	45-min Fire-rated Assembly	2x6	2x4
	(2) 1/2" Type X	No Ceiling Required	No Ceiling Required	2x6	2x6
1-3/4	Unprotected	1/2" Type X	90-min Fire-rated Assembly	2x4	2x4
	(1) 1/2" Type X	No Ceiling Required	1-hour Fire-rated Assembly	2x6	2x4
	(1) 5/8" Type X	No Ceiling Required	45-min Fire-rated Assembly	2x6	2x4
	(2) 1/2" Type X	No Ceiling Required	No Ceiling Required	2x6	2x6

- 1) Rim assembly for fire from either side of wall. "With no load transfer" assumes no load transfers to the adjacent rim board if the fire exposed rim board fails.
- 2) Gypsum wallboard shown on the ceiling is to protect the Rim Board only. It does not necessarily cause the floor assembly to be rated.
- 3) Attach 1-layer Type X (1/2 or 5/8-inch) gypsum wallboard to Rim Board with 1-1/2-inch Type W drywall screws spaced 12 inches o.c.
- 4) Attach 2-layer Type X (1/2 or 5/8-inch) gypsum wallboard to Rim Board with 2-inch Type W drywall screws spaced 12 inches o.c.
- 5) Provide min. 1-3/4-inch bearing for I-joist.
- 6) Use only fire rated gypsum wallboard. Type C may be substituted for Type X.
- 7) Rim Board and gypsum wallboard thickness are shown as minimums. Thicker Rim Board and gypsum wallboard may be substituted.
- 8) Toe nailing from the I-joist flange to the rim is permitted. When 2-layer (or more) gypsum wallboards are used, I-joist end nails shall be 16d box (0.135 inch x 3-1/2 inches) nails.
- 9) Rim board shall be sized for vertical and lateral load.
- 10) Stud size may be reduced if the gypsum protection is discontinuous, provided that other requirements in the code are satisfied.

REPRESENTING THE ENGINEERED WOOD INDUSTRY

APA – The Engineered Wood Association is an approved national standards developer accredited by American National Standards Institute (ANSI). APA publishes ANSI standards and Voluntary Product Standards for wood structural panels and engineered wood products. APA is an accredited certification body under ISO/IEC 17065 by Standards Council of Canada (SCC), an accredited inspection agency under ISO/IEC 17020 by ANSI National Accreditation Board (ANAB), and an accredited testing organization under ISO/IEC 17025 by ANAB. APA is also an approved Product Certification Agency, Testing Laboratory, Quality Assurance Entity, and Validation Entity, and Product Evaluation Entity by the State of Florida, and an approved testing laboratory by City of Los Angeles.

**APA – THE ENGINEERED WOOD ASSOCIATION
HEADQUARTERS**

7011 So. 19th St. • Tacoma, Washington 98466
Phone: (253) 565-6600 • Fax: (253) 565-7265 • Internet Address: www.apawood.org

PRODUCT SUPPORT HELP DESK
(253) 620-7400 • *E-mail Address:* help@apawood.org

DISCLAIMER

APA Product Report® is a trademark of *APA – The Engineered Wood Association*, Tacoma, Washington. The information contained herein is based on the product evaluation in accordance with the references noted in this report. No warranties, express or implied, including as to fitness for a particular purpose, are made regarding this report. Neither APA nor its members shall be liable, or assume any legal liability or responsibility, for damages, direct or indirect, arising from the use, application of, and/or reference to opinions, findings, conclusions or recommendations included in this report. Consult your local jurisdiction or design professional to assure compliance with code, construction, and performance requirements. Because APA has no control over quality of workmanship or the conditions under which engineered wood products are used, it cannot accept responsibility for product performance or designs as actually constructed.